

Wiringkit

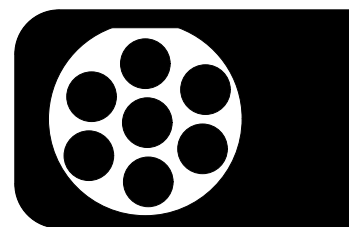

D	Einbauanleitung
GB	Installation instructions
F	Consignes de montage
NL	Montagehandleiding
DK	Montagevejledning
N	Monteringsinstruksjon
S	Installationsanvisning
FIN	Asennusohje
I	Istruzioni per il montaggio
E	Instrucciones de montaje
P	Instruções de montagem
GR	Οδηγίες εγκατάστασης
CZ	Návod k montáži
SLO	Navodilo za vgradnjo
SK	Montážny návod
PL	Instrukcja montażu
TR	Montaj talimatı
H	Beépítési útmutató
HR	Upute o ugradnji
BUL	Инструкция за монтаж
RO	Instrucțiuni de montaj
RU	Инструкция по монтажу и установке
LT	Montavimo informacija
LV	Iemontēšanas pamācība
EST	Paigaldusjuhend

756573 VOLKSWAGEN

- **Passat Limousine** 03/05 >> 10/10
- **Passat Variant** 08/05 >> 10/10
- **Passat CC** 06/08 >> 12/11
- **Jetta** 08/05 >> 12/10

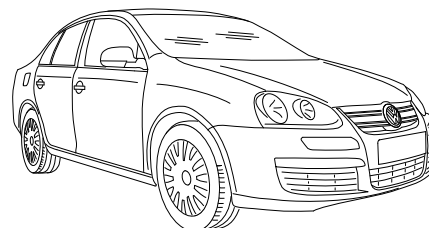
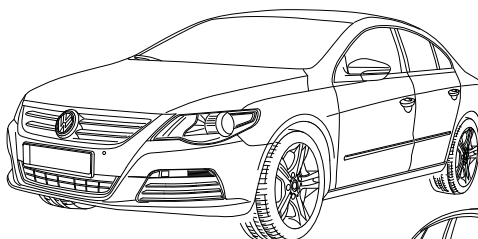
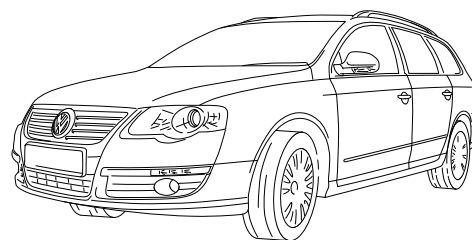
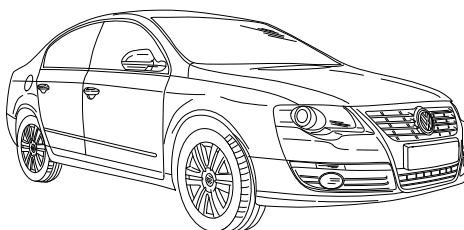

ROUTING

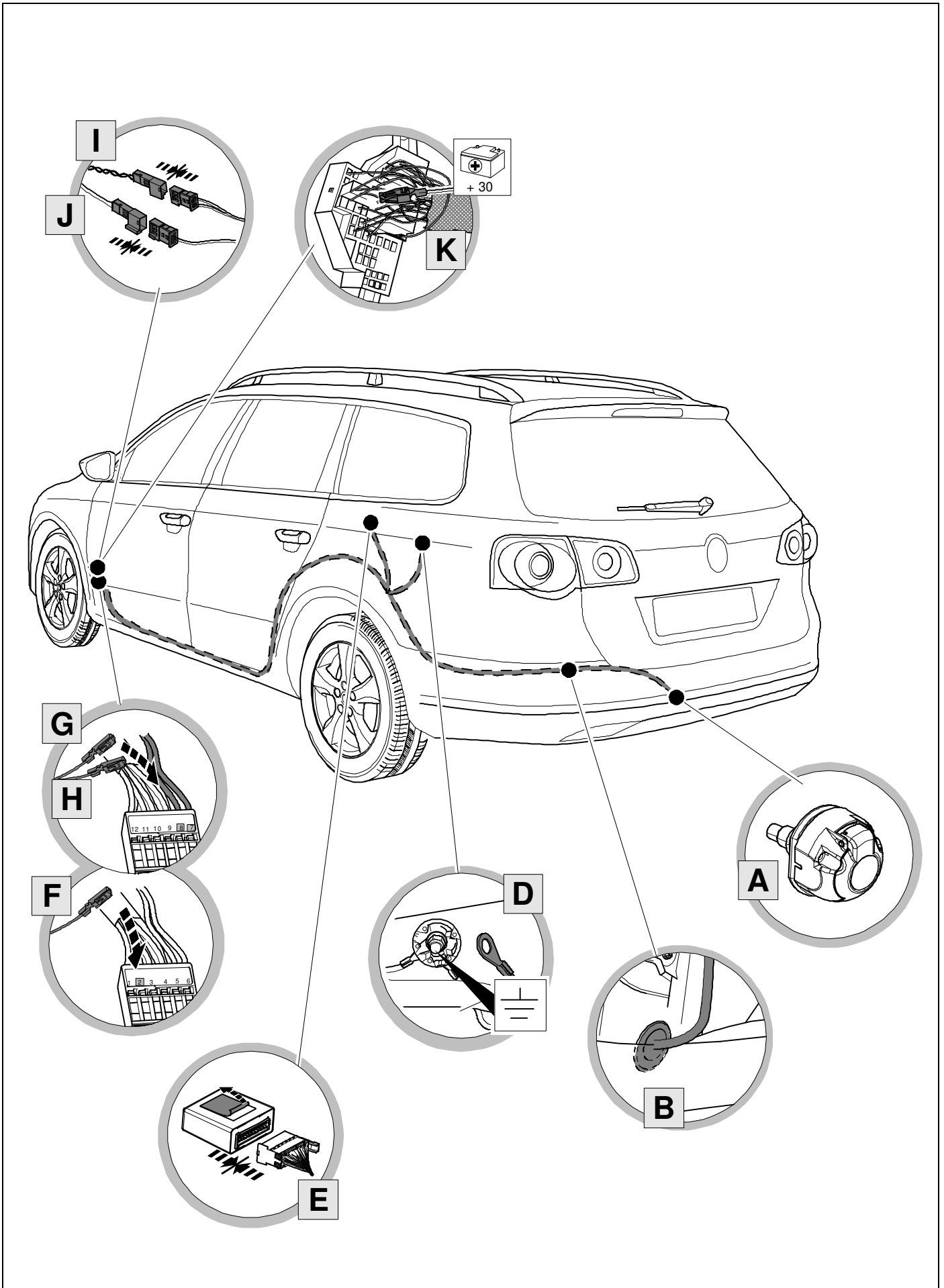

KIT

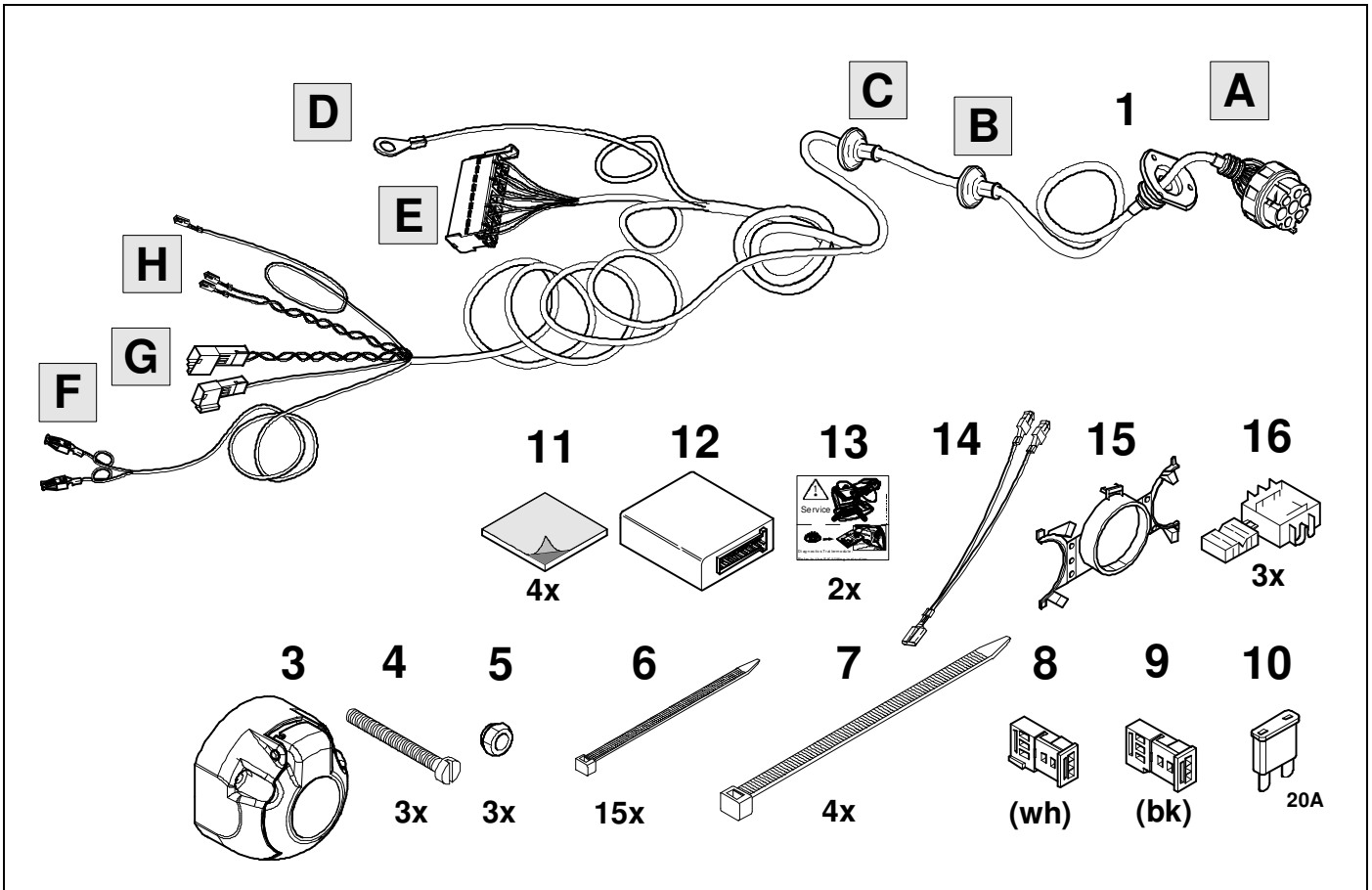

TOOLS

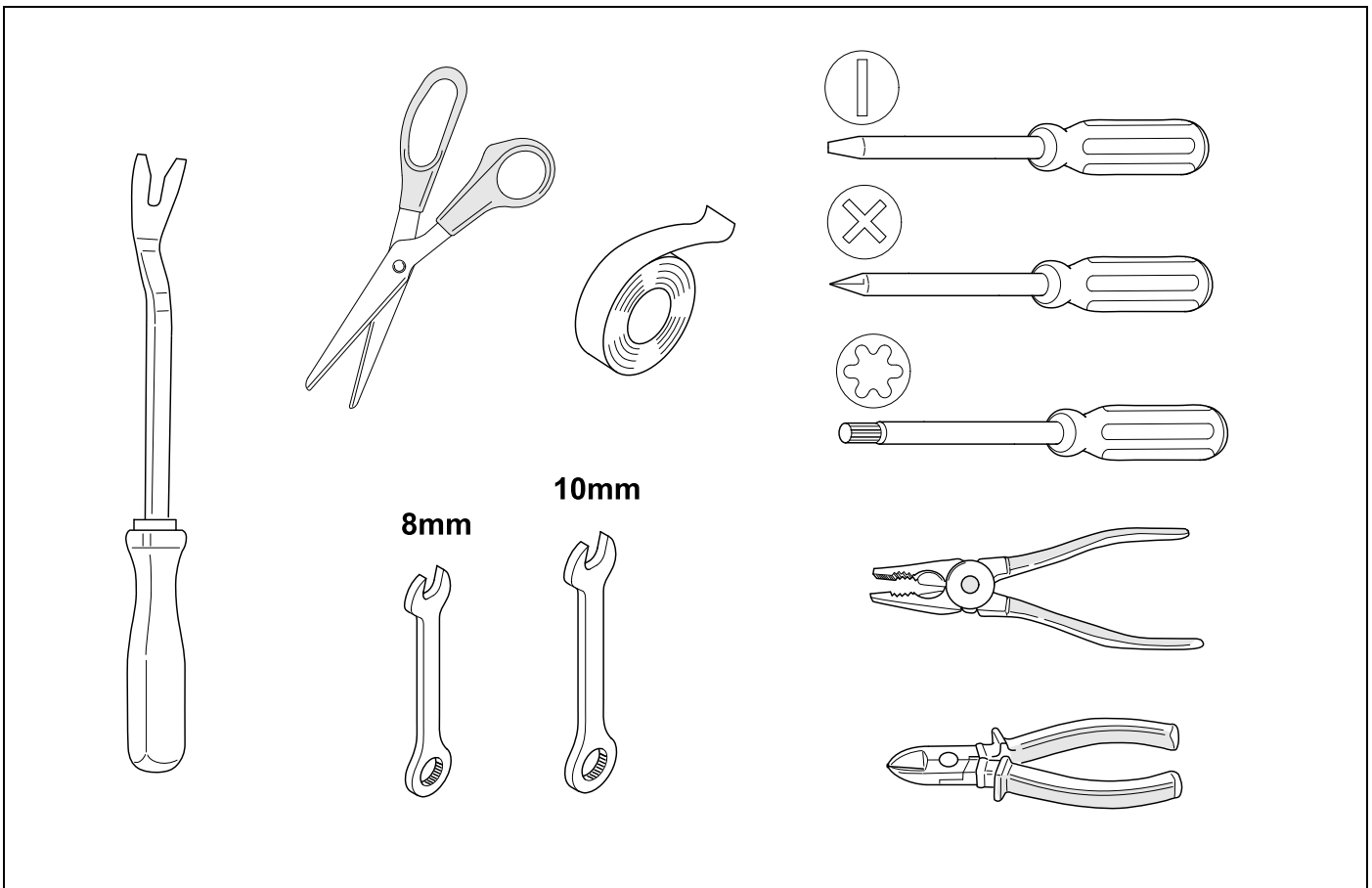

1

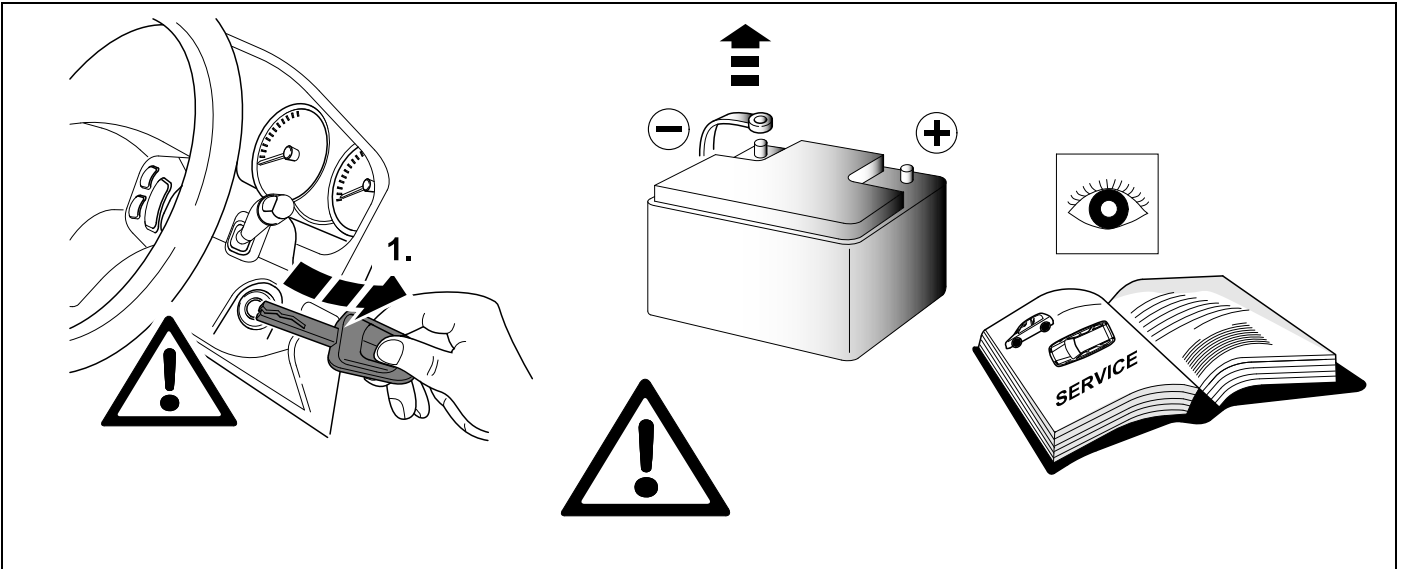

2 REMOVE

Passat Limousine / Passat CC / Jetta

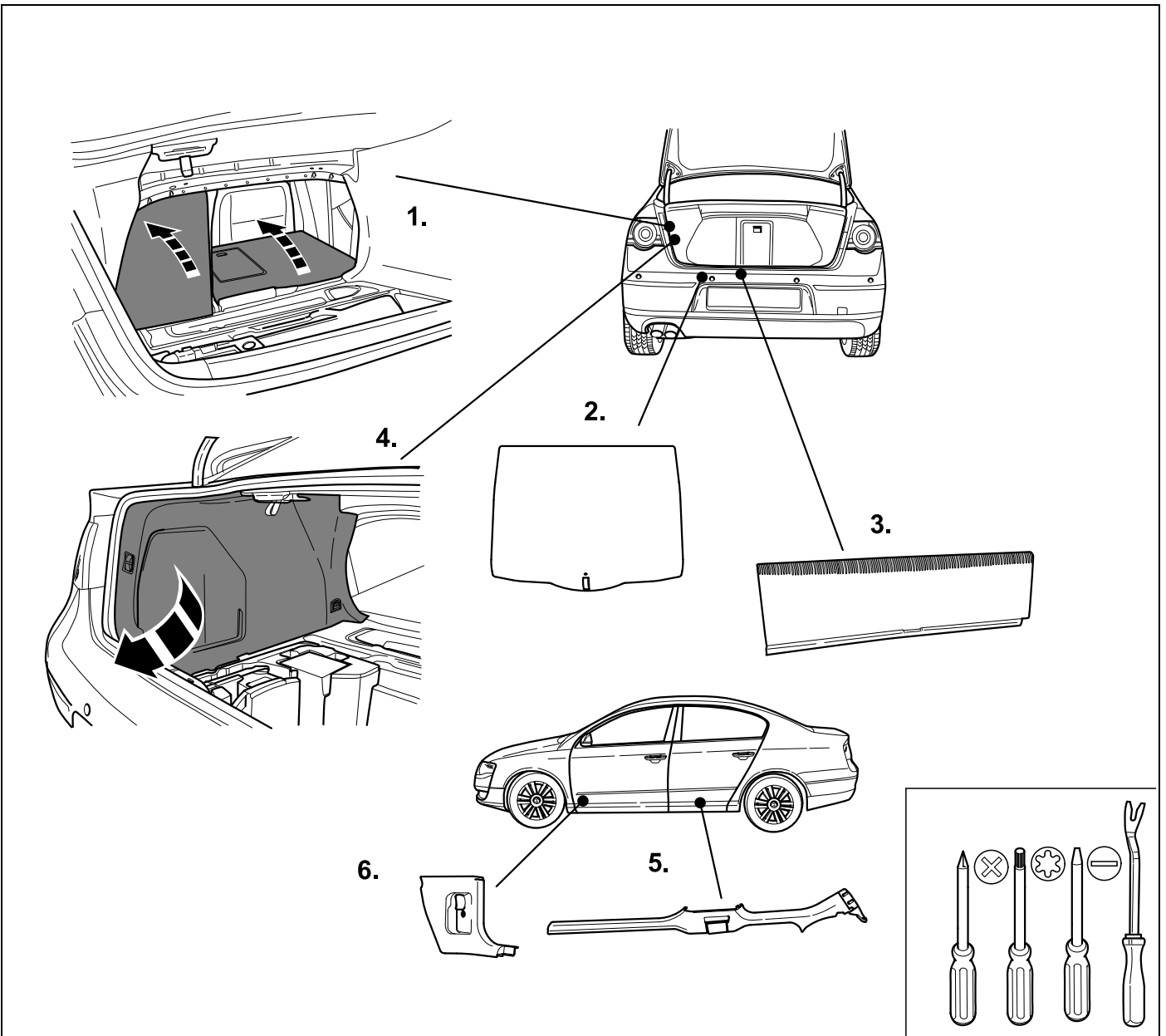

3 REMOVE

Passat Variant

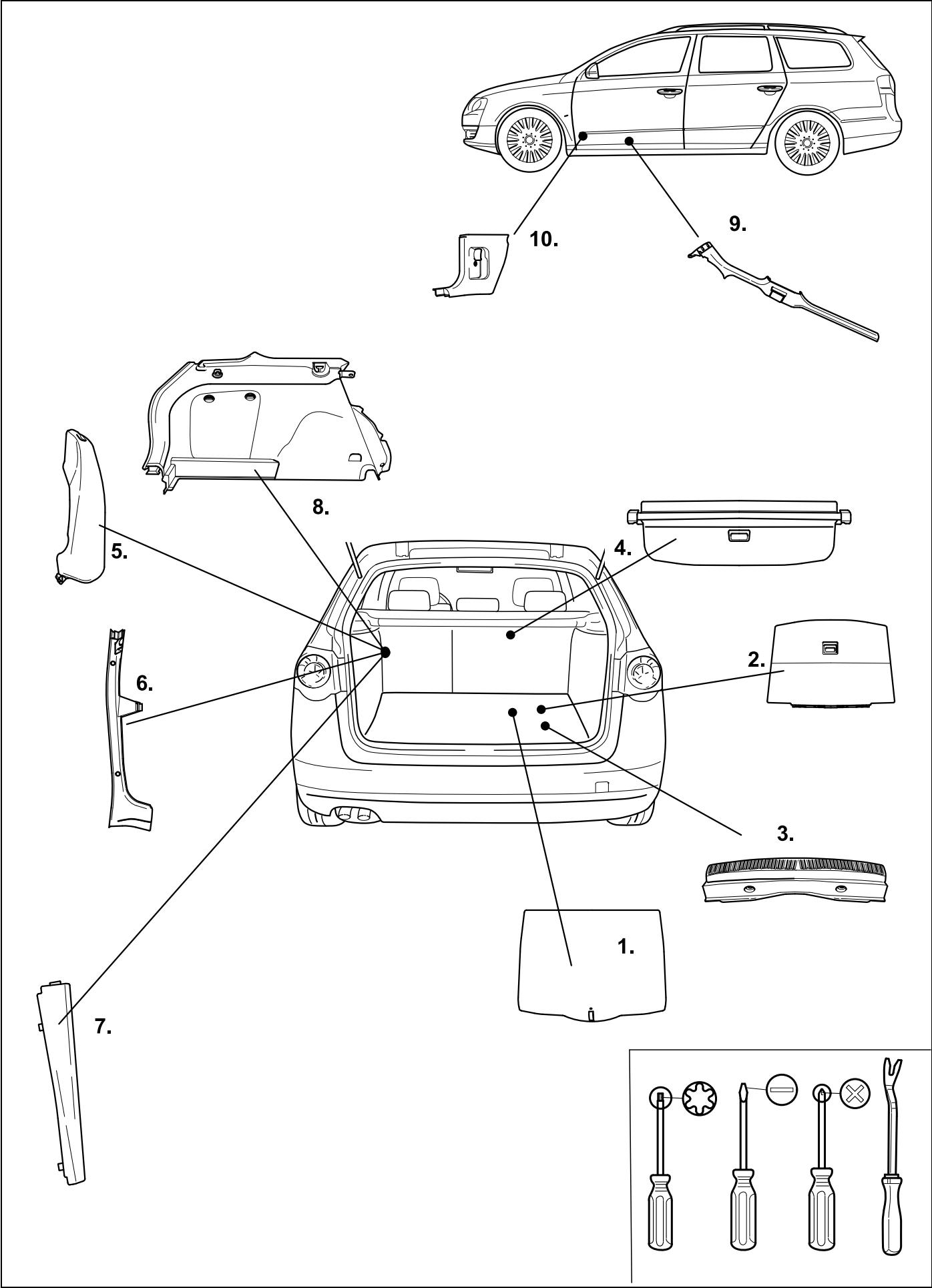

4

Passat Limousine / Jetta

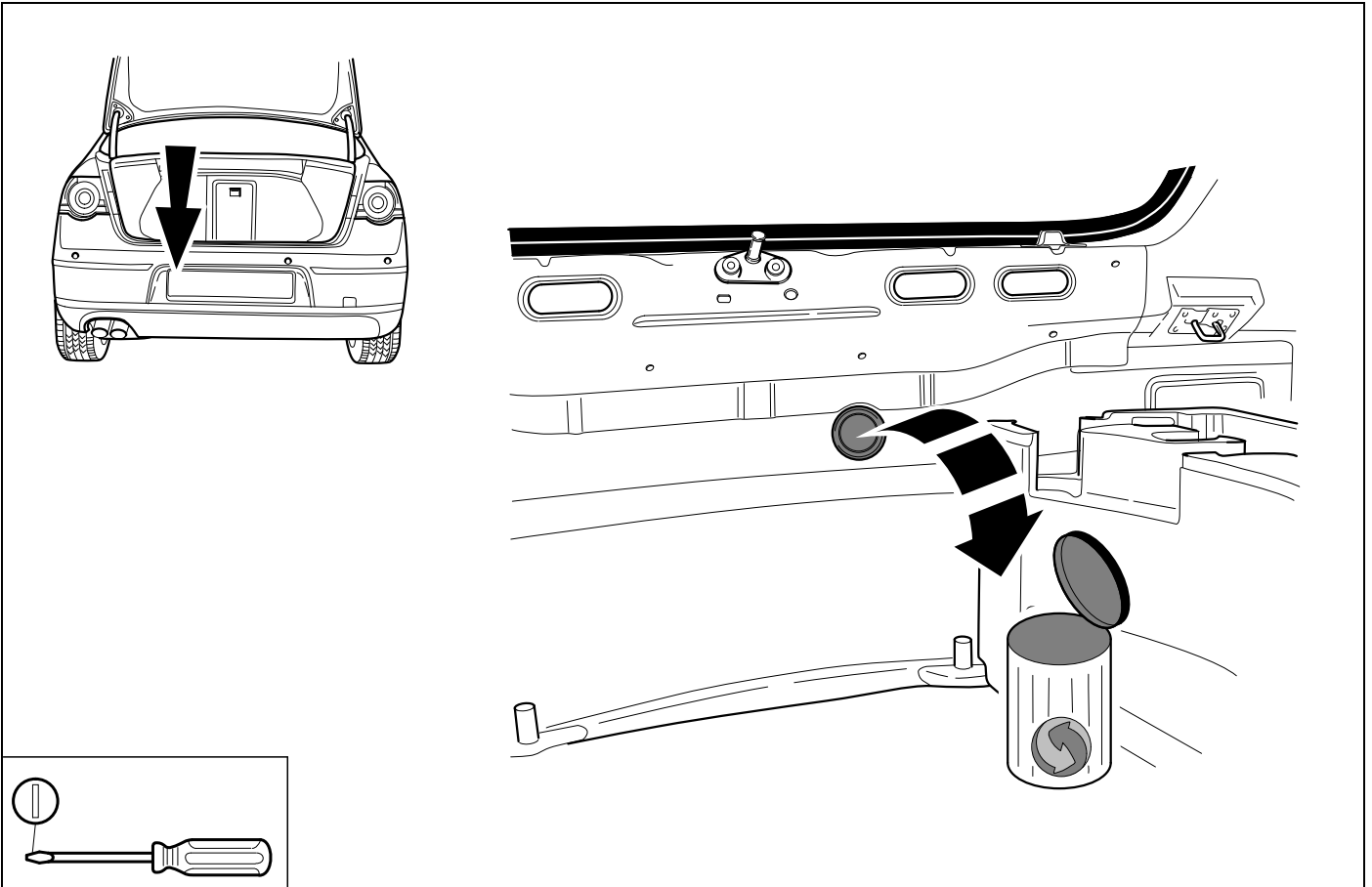

5

Passat Variant / Passat CC

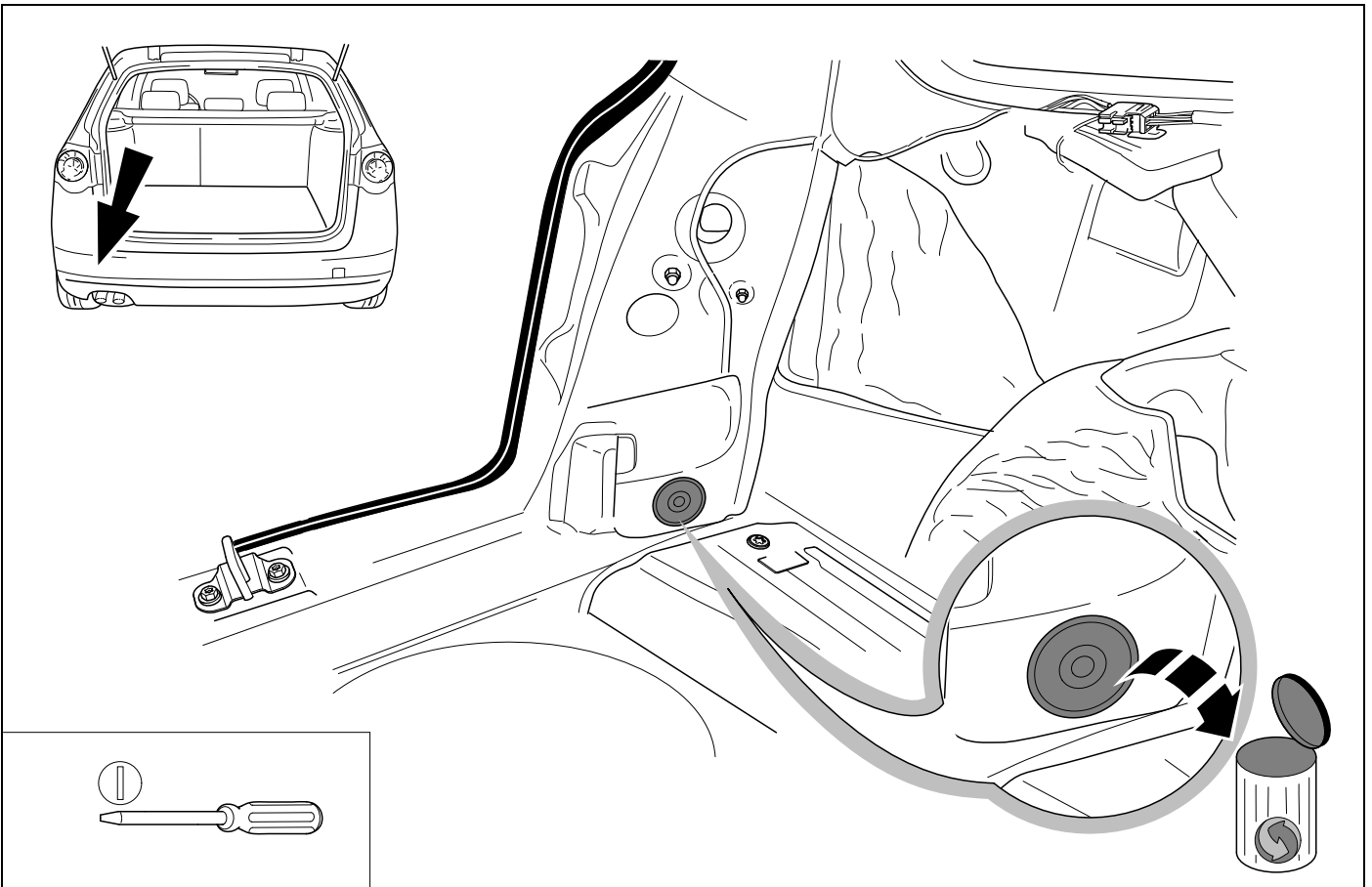

6

Passat Limousine / Jetta

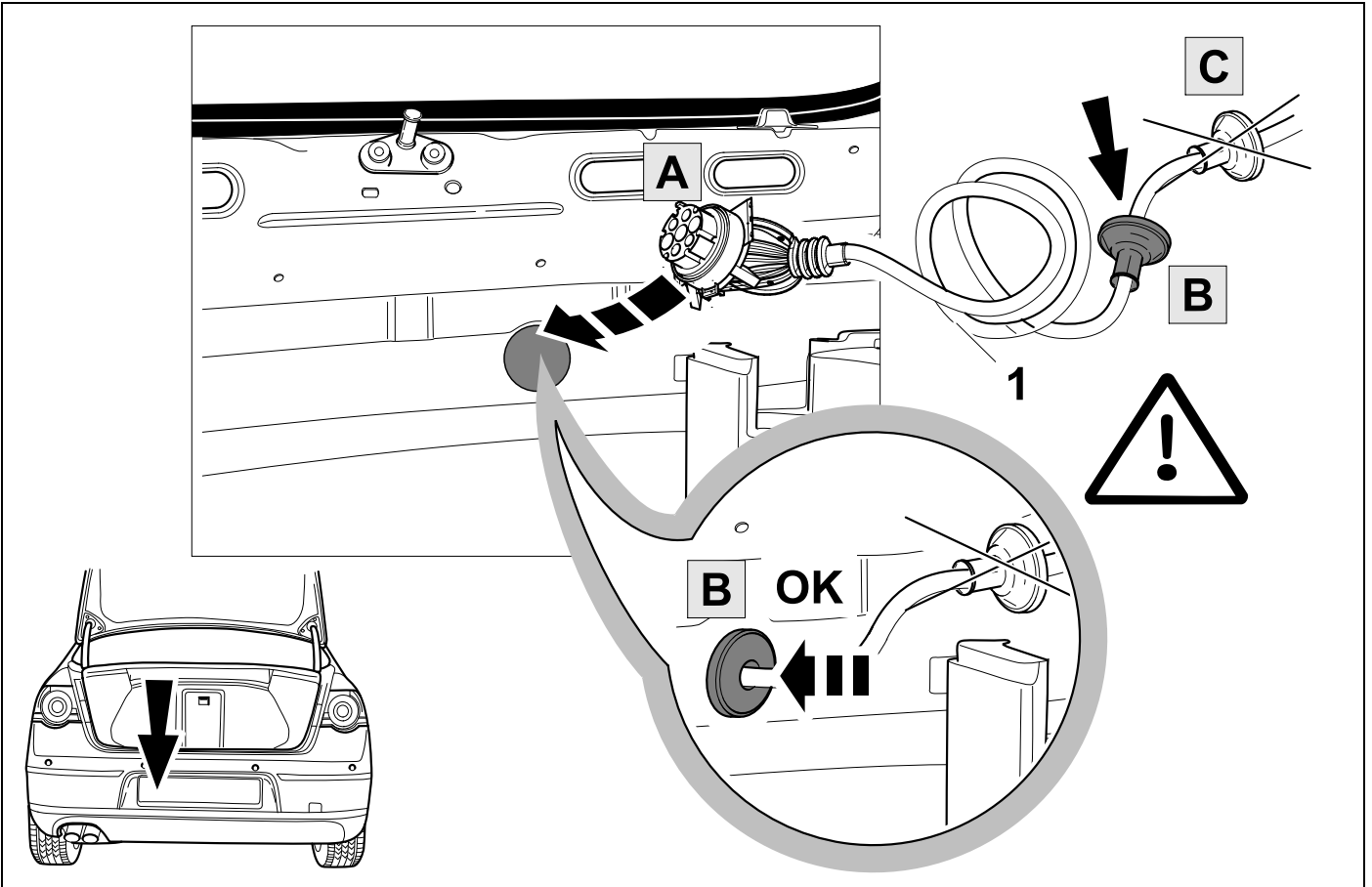

7

Passat Variant / Passat CC

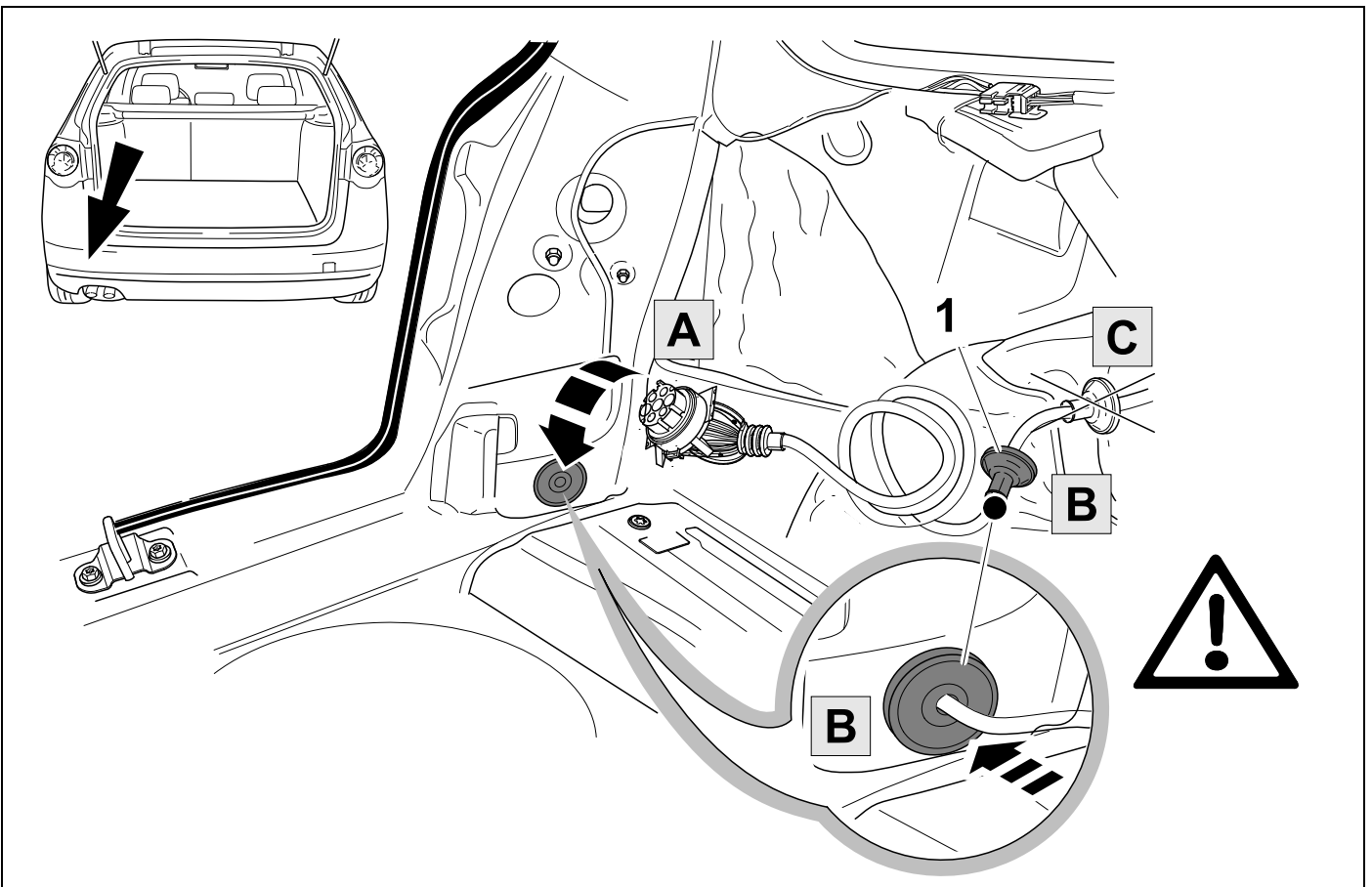

8

Passat Limousine / Jetta

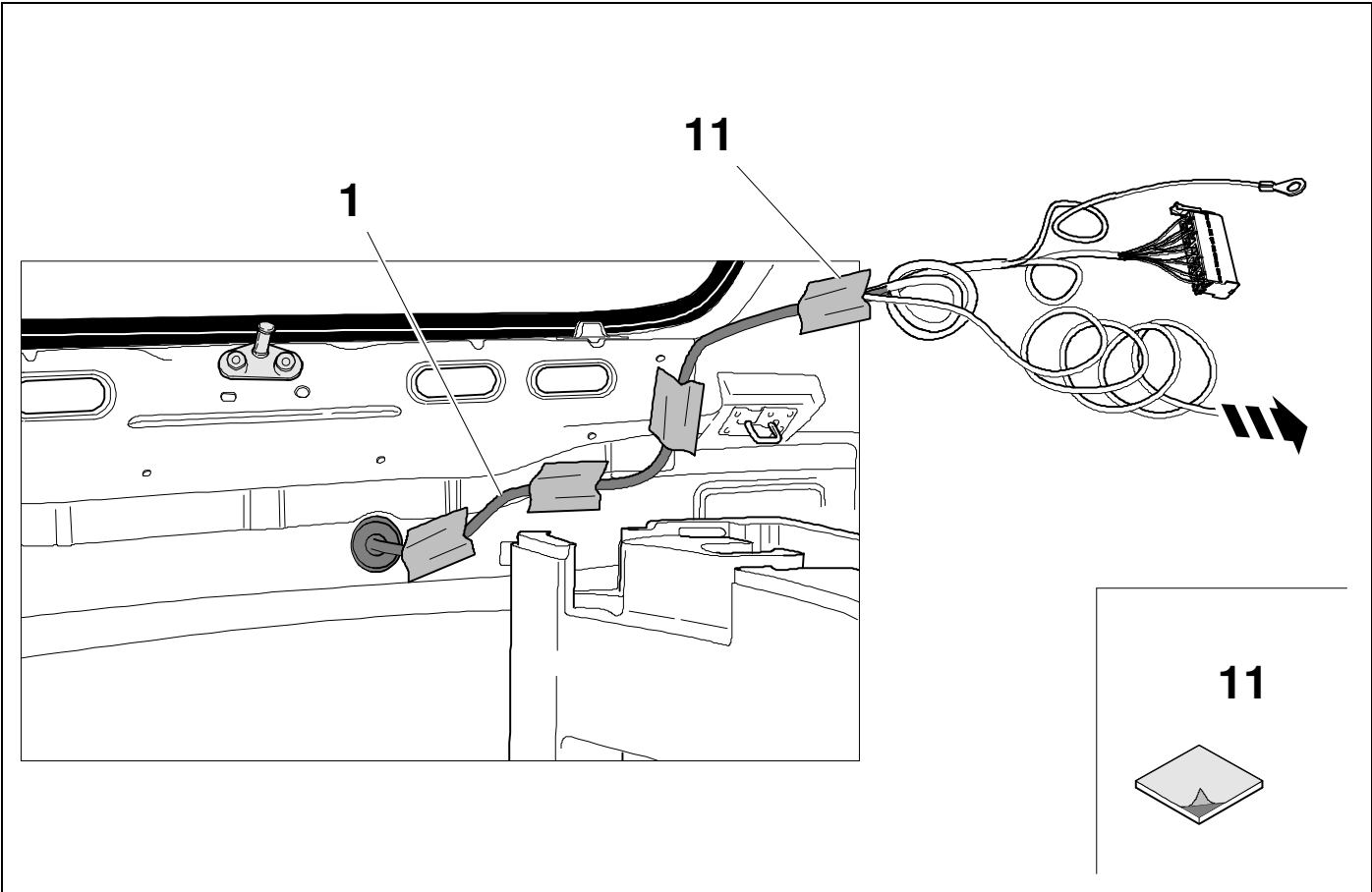

9

Passat Variant

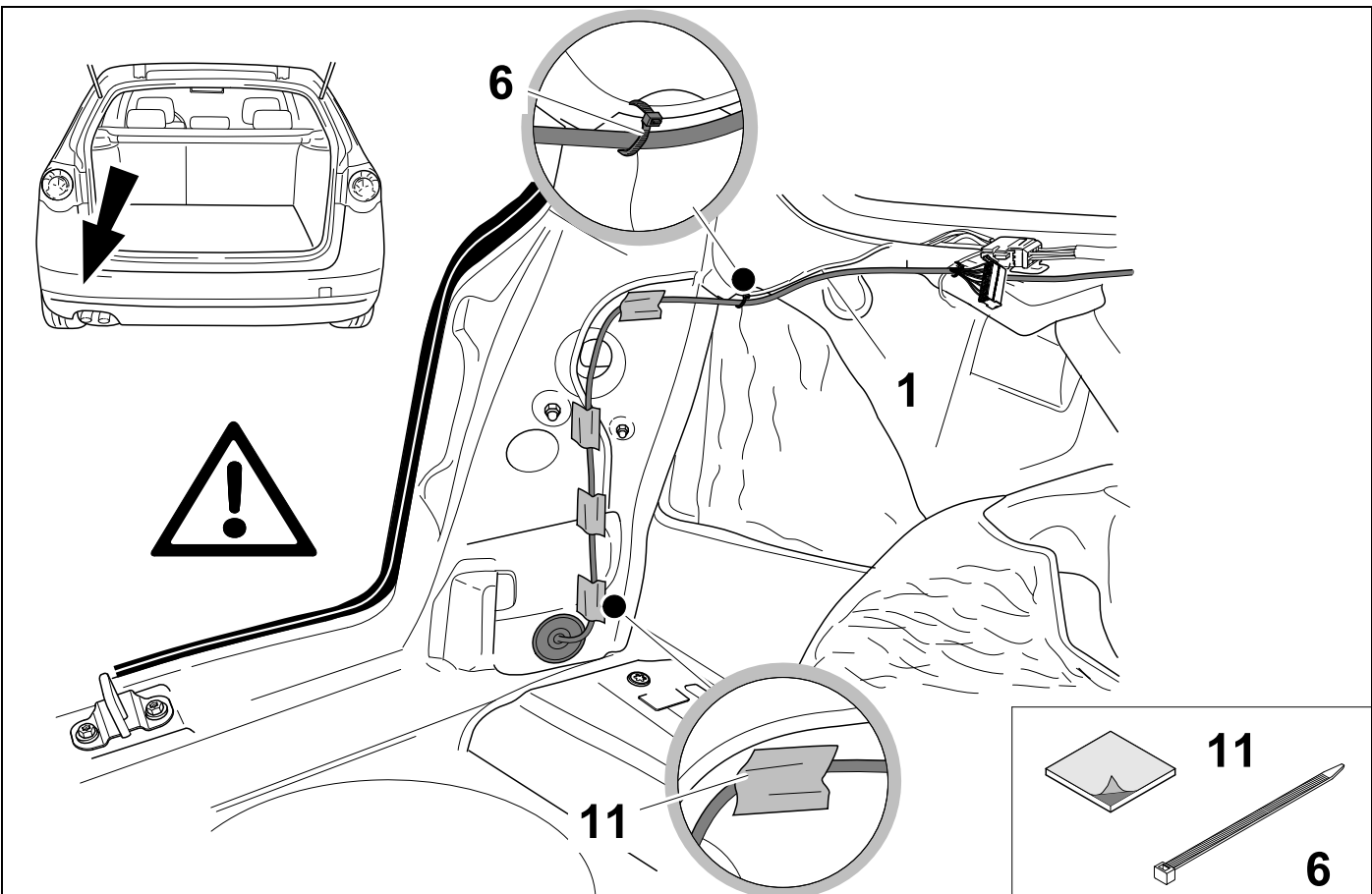

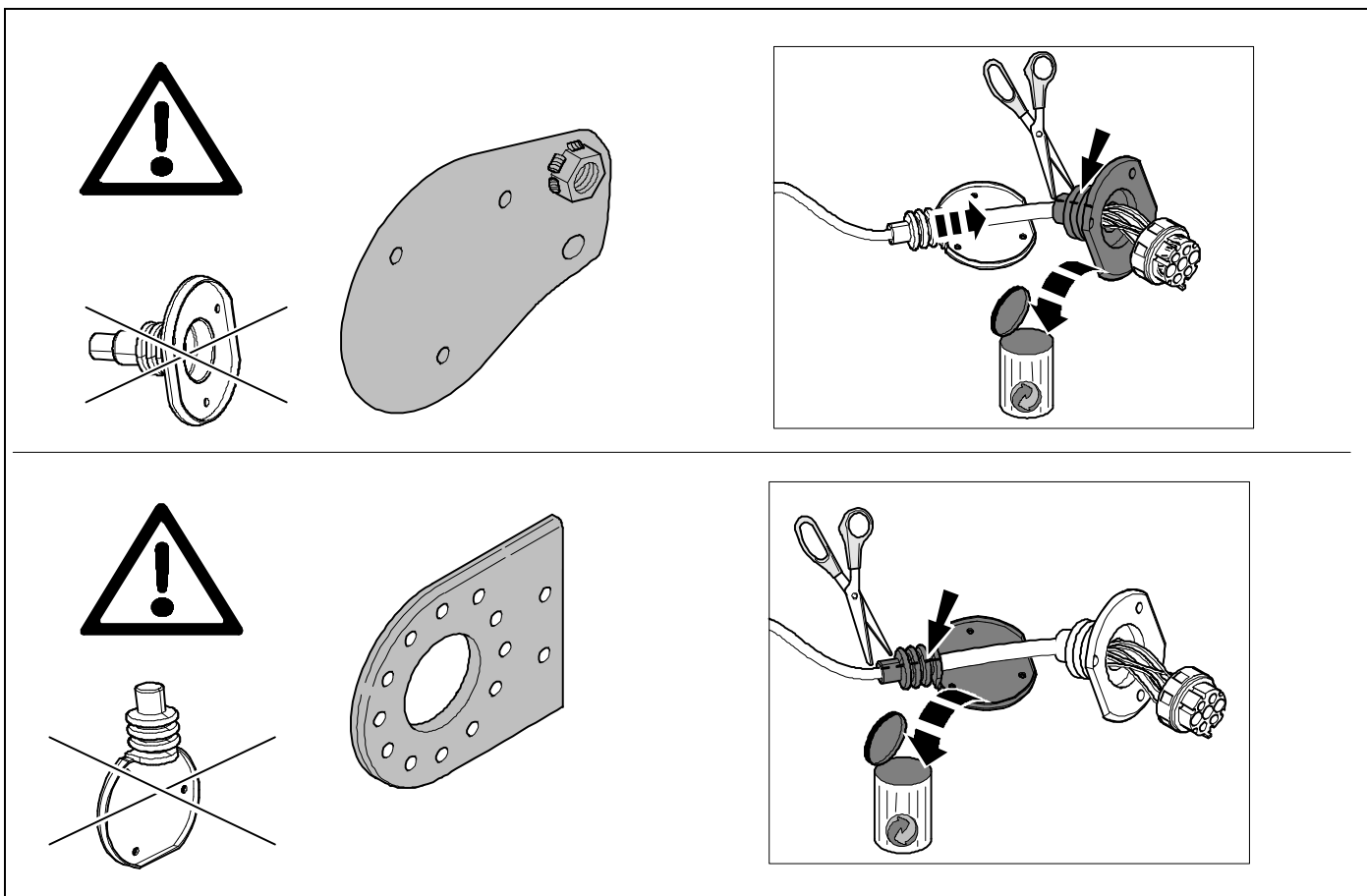
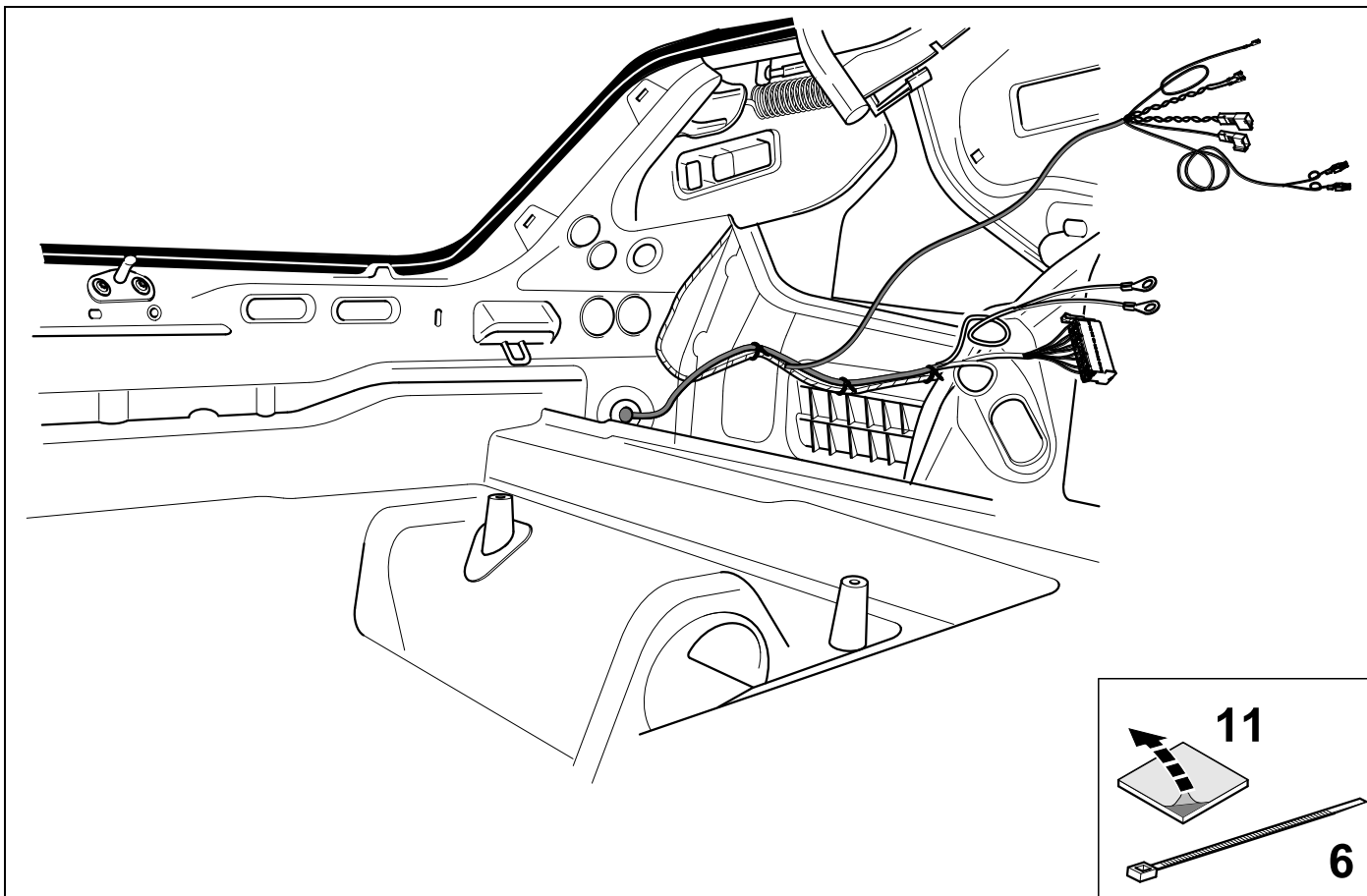

12



14

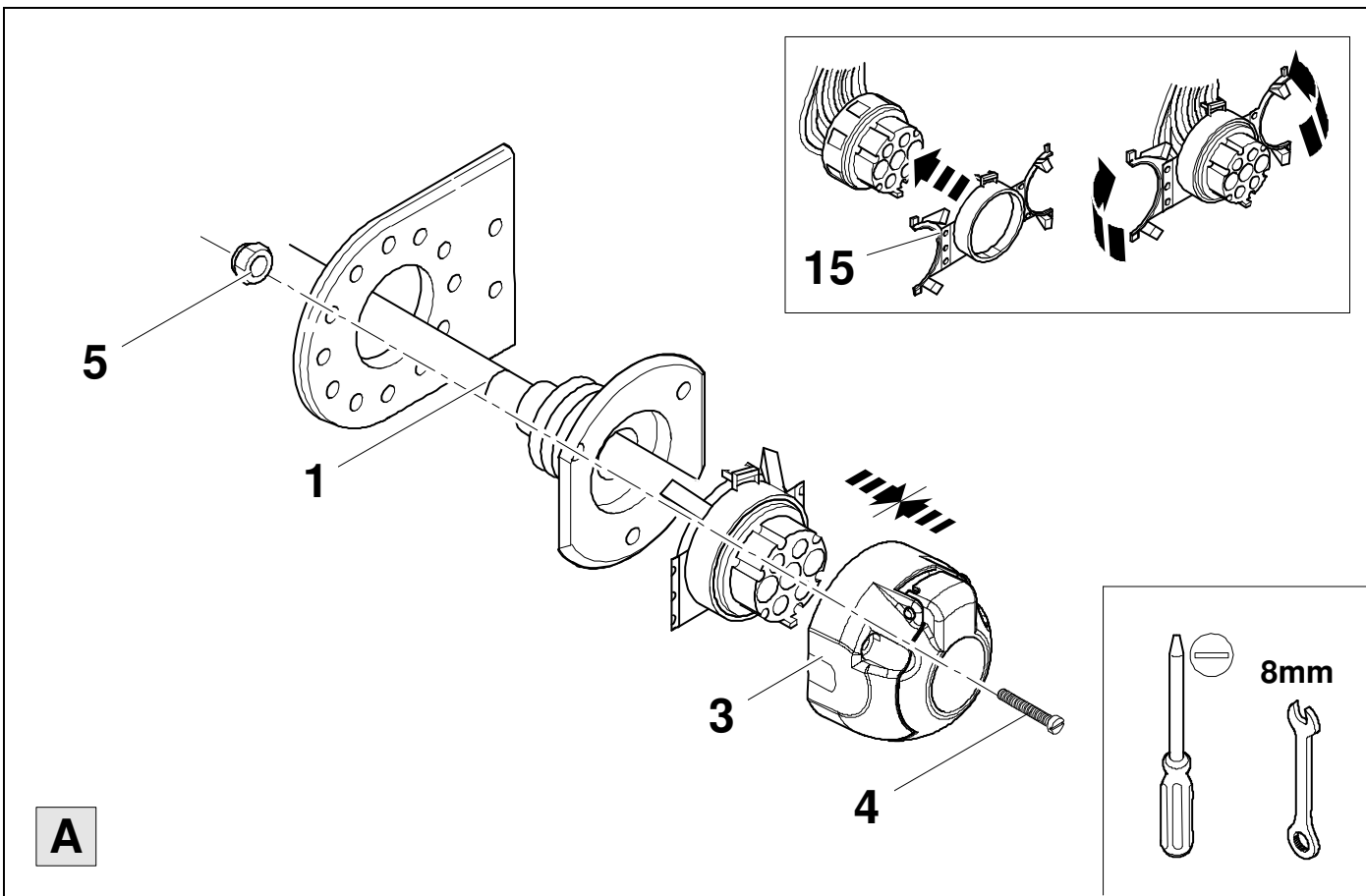

13



14

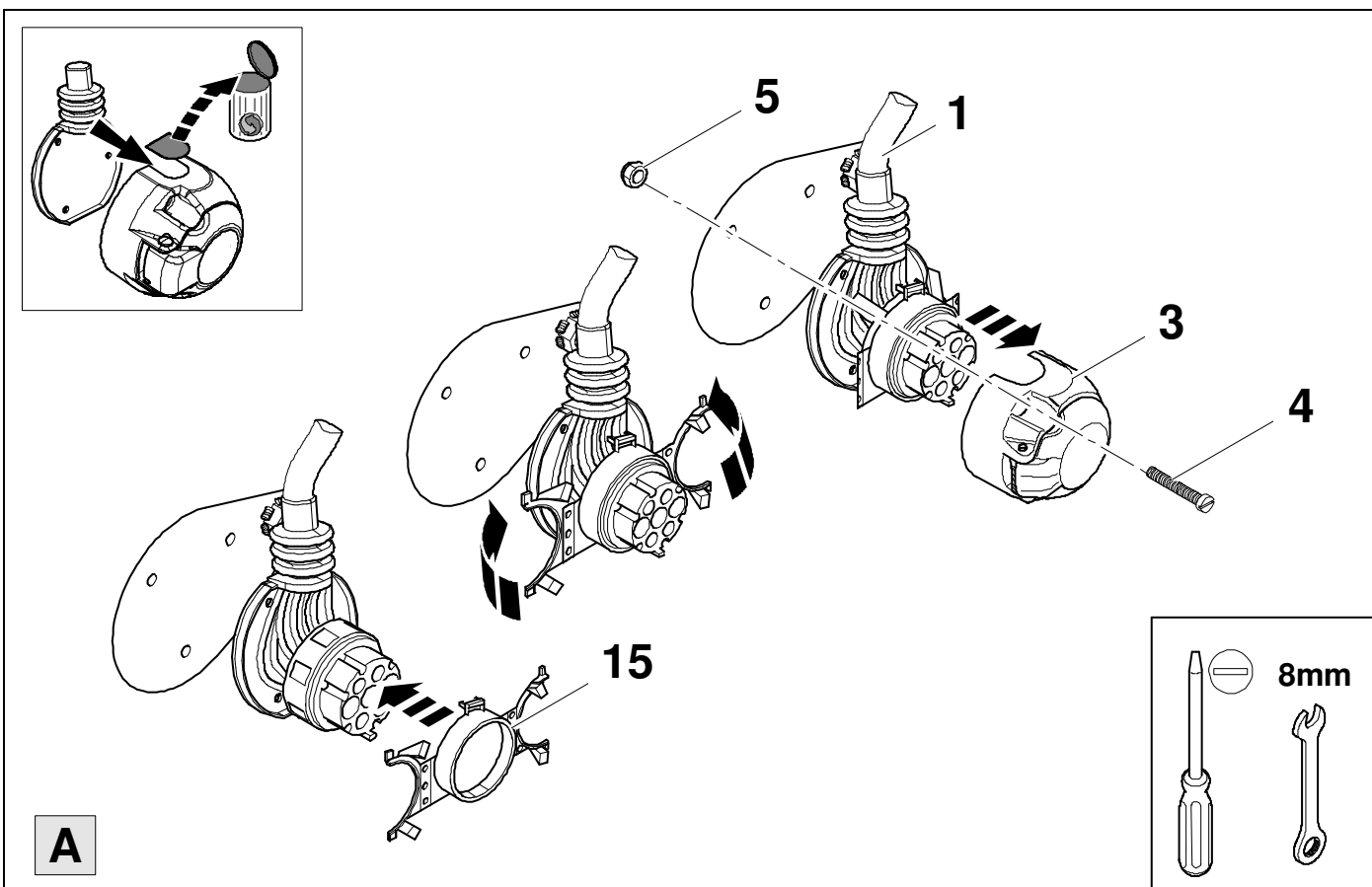



1/L	bk/wh	
2/54g	gy	
3/31	wh/bn	
4/R	bk/gn	
5/58R	gy/rd	
6/54	bk/rd	
7/58L	gy/bk	

15	bk	wh	gy	gn	rd	bu	ye	bn	pu	or	no
(D)	schwarz	weiss	grau	grün	rot	blau	gelb	braun	violett	orange	nicht belegt
(GB)	black	white	grey	green	red	blue	yellow	brown	purple	orange	not occupied
(F)	noir	blanc	gris	vert	rouge	bleu	jaune	brun	violet	orange	inutilisé
(NL)	zwart	wit	grijs	groen	rood	blauw	geel	bruin	violet	oranje	niet aangesloten
(DK)	sort	hvid	grå	grøn	rød	blå	gul	brun	violet	orange	ikke anvendt
(N)	svart	hvit	grå	grønn	rød	blå	gul	brun	fiolett	oransje	ikke i bruk
(S)	svart	vit	grå	grön	röd	blå	gul	brun	violett	orange	ej använd
(FIN)	musta	valkoinen	harmaa	vihreä	punainen	sininen	keltainen	ruskea	violetti	oranssi	ei varattu
(I)	nero	bianco	grigio	verde	rosso	blu	giallo	marrone	viola	arancione	libero
(E)	negro	blanco	gris	verde	rojo	azul	amarillo	marrón	violeta	anaranja-do	no ocupado
(P)	preto	branco	cinzento	verde	vermelho	azul	amarelo	castanho	violeta	laranja	não ocupado
(GR)	μαύρος	λευκός	Γκρι	πράσινος	κόκκινος	μπλε	κίτρινος	καφέ	Μωβ	πορτοκαλί	δεν είναι κατ'επιτημένως
(PL)	czarny	biały	szary	zielony	czerwony	niebiesko	żółty	brazowy	fioletowy	pomarańczowy	wolny
(CZ)	černý	bílý	šedý	zelený	červený	modrý	žlutý	hnědý	fialový	oranžový	neobsazen
(TR)	siyah	beyaz	gri	yeşil	kırmızı	mavi	sarı	kahverengi	mor	portakal rengi	boş
(H)	fekete	fehér	szürke	zöld	piros	kék	sárga	barna	ibolyakék	narancssárga	nem foglalt
(HR)	crno	bijelo	sivo	zeleno	crveno	plavo	zuto	smeđe	ljubičasto	narandasto	nije zauzeto
(BUL)	черен	бял	сив	зелен	червен	син	жълт	кафяв	виолетов	оранжев	свободно
(RO)	negru	alb	gri	verde	roșu	albastru	galben	maro	violet	portocaliu	liber
(RU)	черный	белый	серый	зеленый	красный	голубой	жёлтый	коричневый	пурпурный	оранжевый	свободно
(LT)	juoda	balta	pilka	žalia	raudona	mėlyna	geltona	ruda	purpurinė	oranžinė	laisva
(LV)	melna	balta	pelēka	zaļa	sarkana	zila	dzeltena	brūna	purpur-sarkana	oranža	brīvs
(EST)	must	valge	hall	roheline	punane	sinine	kollane	pruun	purpur-punane	oraanž	vaba
(SLO)	črna	bela	siva	zelena	rdeča	modra	rumena	smeđ	vijoličast	oranžen	ni zasedeno
(SK)	čierny	biely	šedý	zelený	červený	modrý	žltý	hnědý	fialový	pomaraňový	neobsadený

16

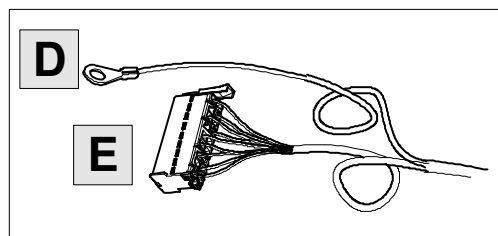
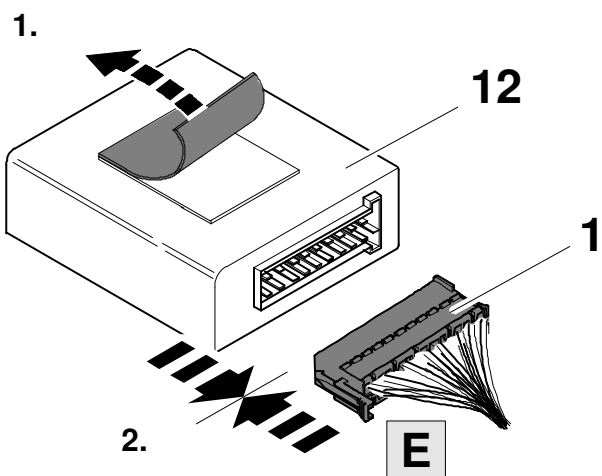

17

Passat Variant / Limousine / Passat CC

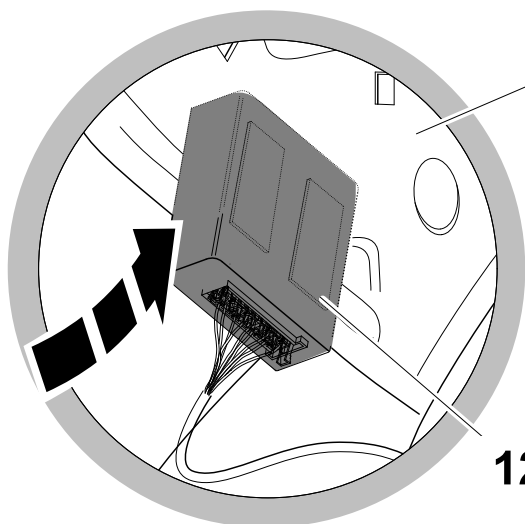
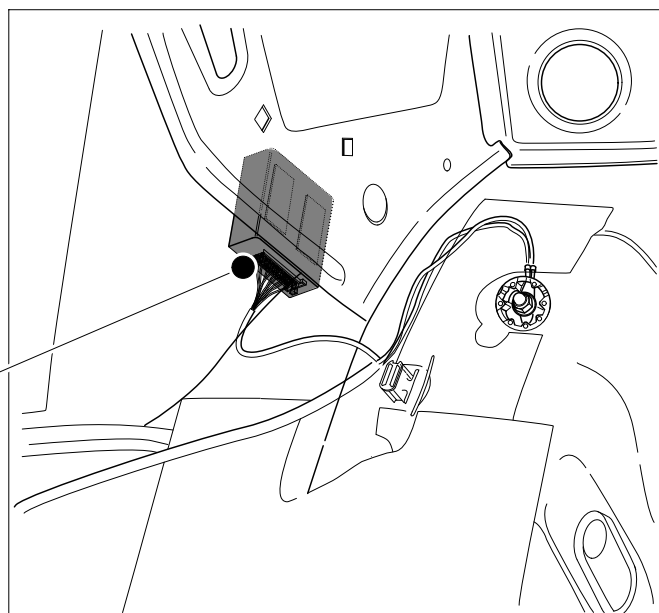
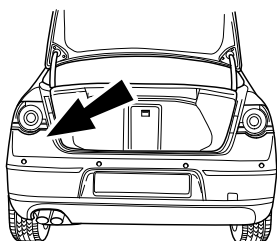

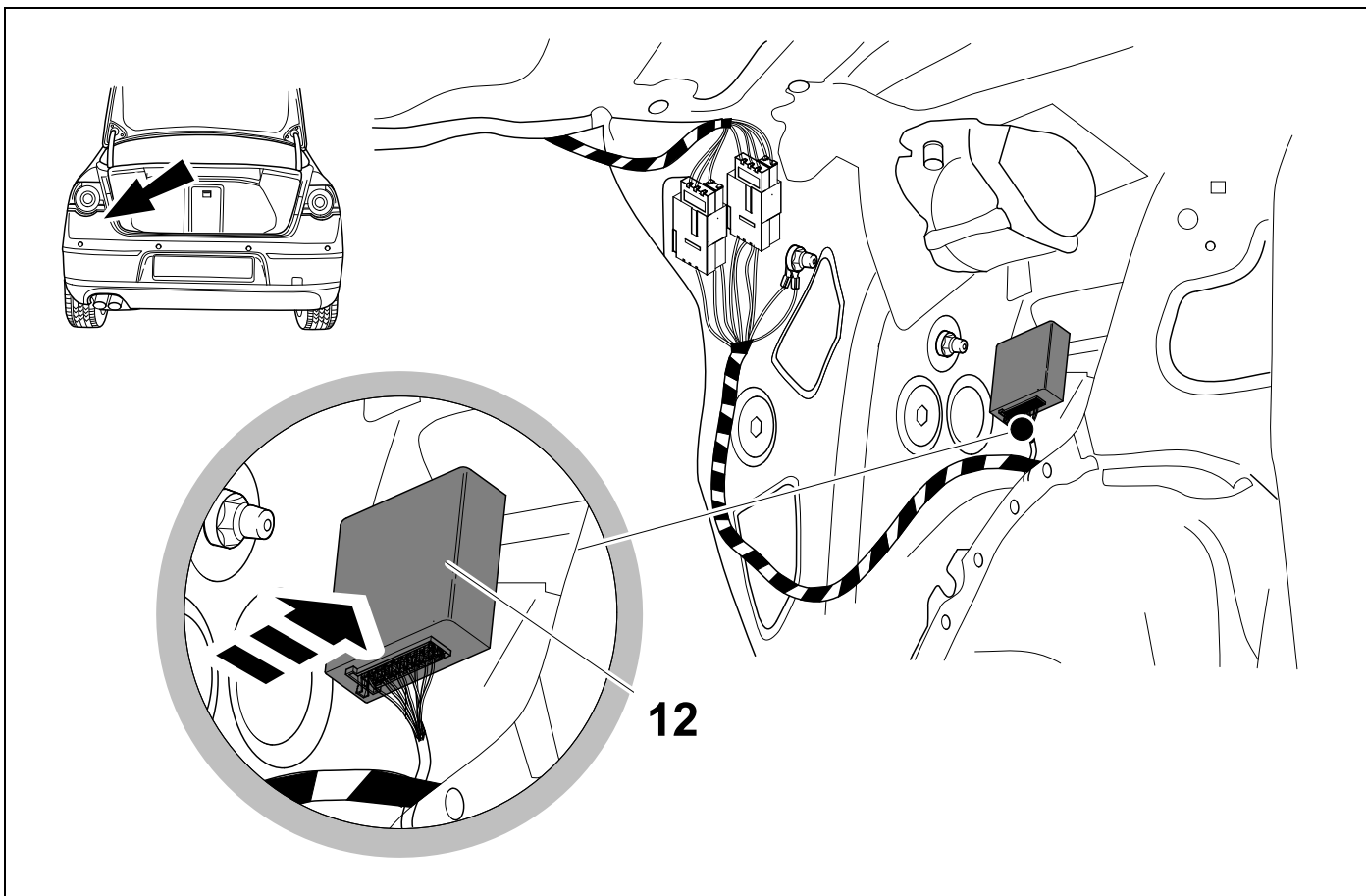
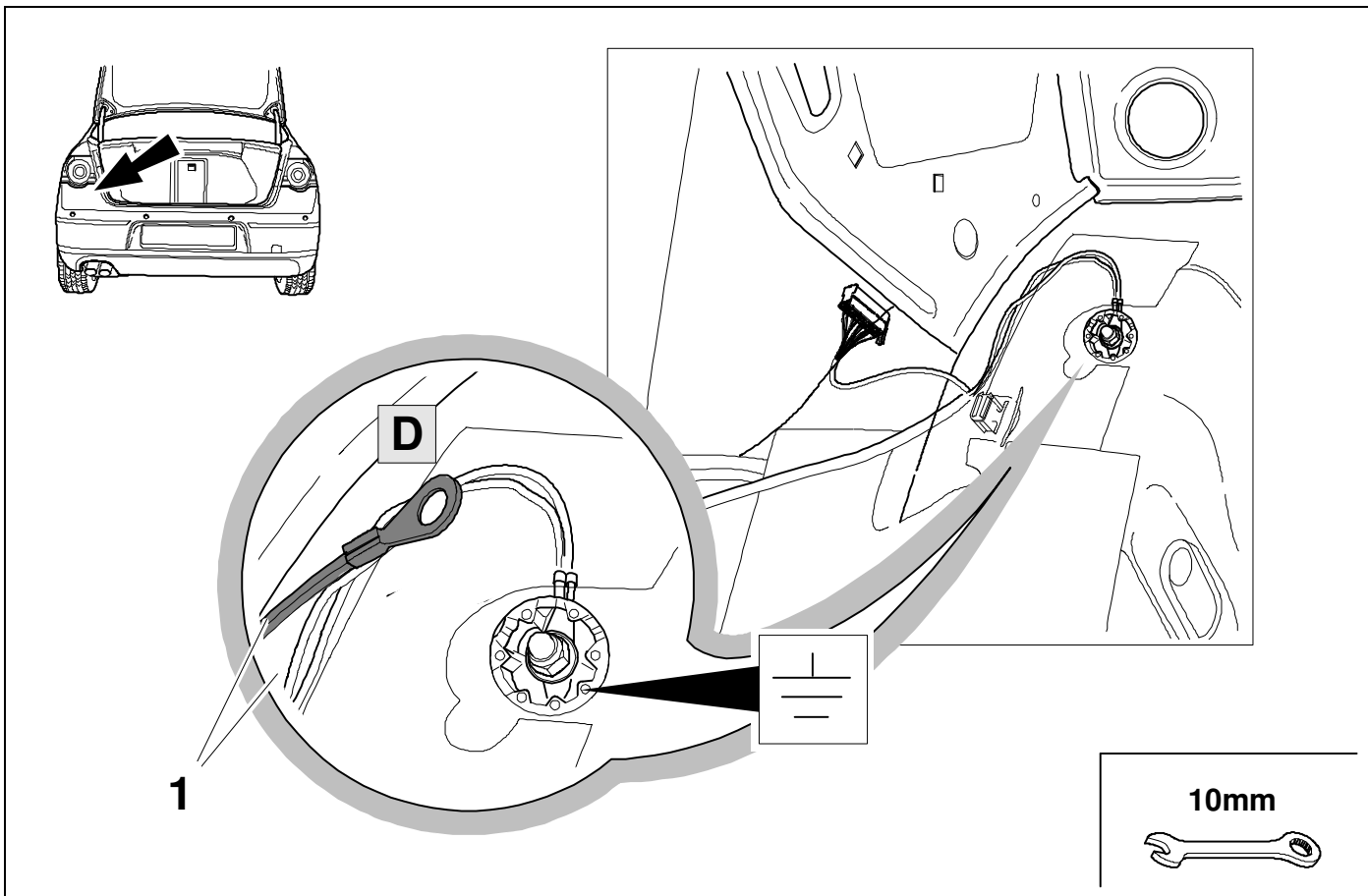

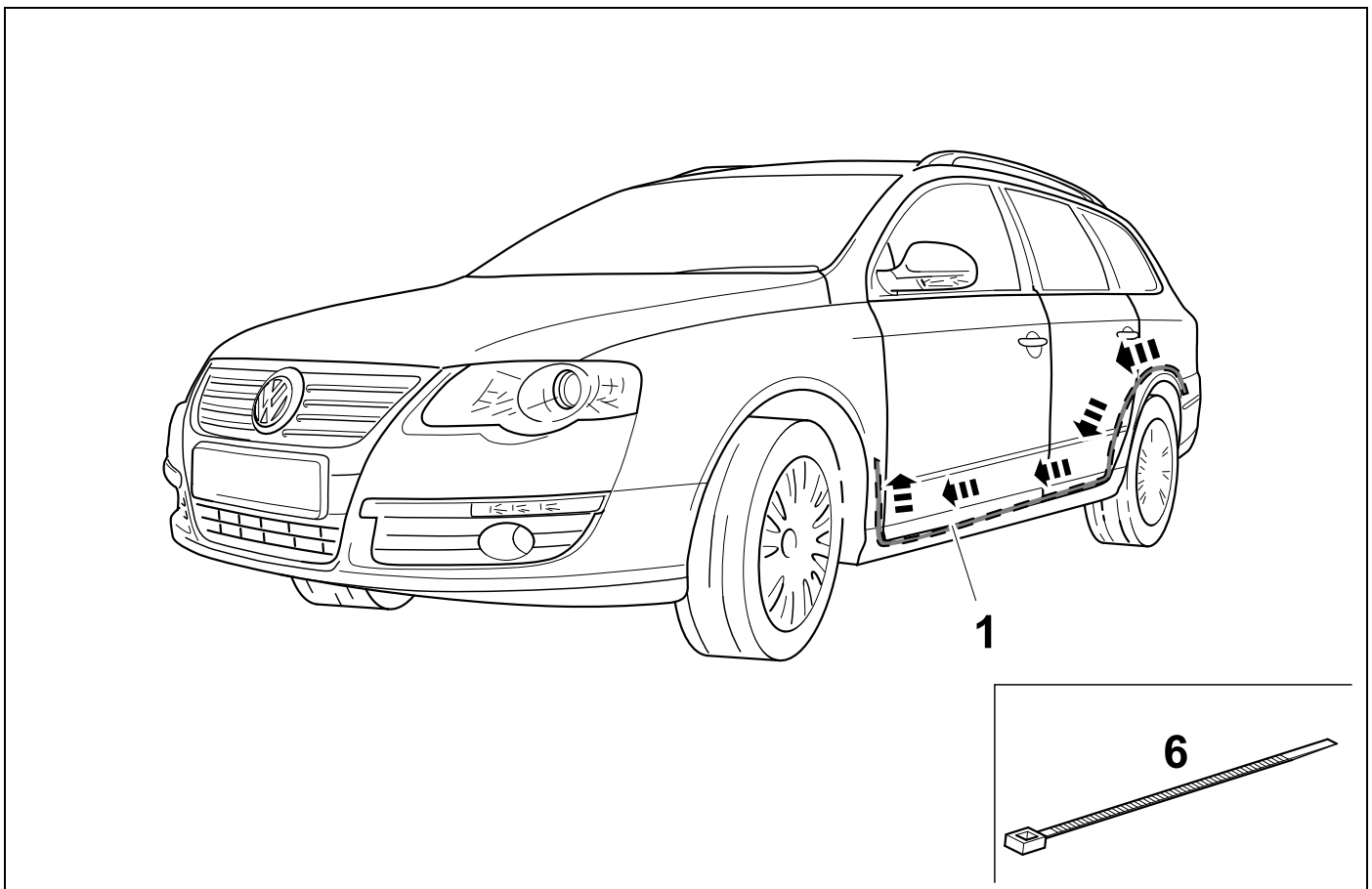
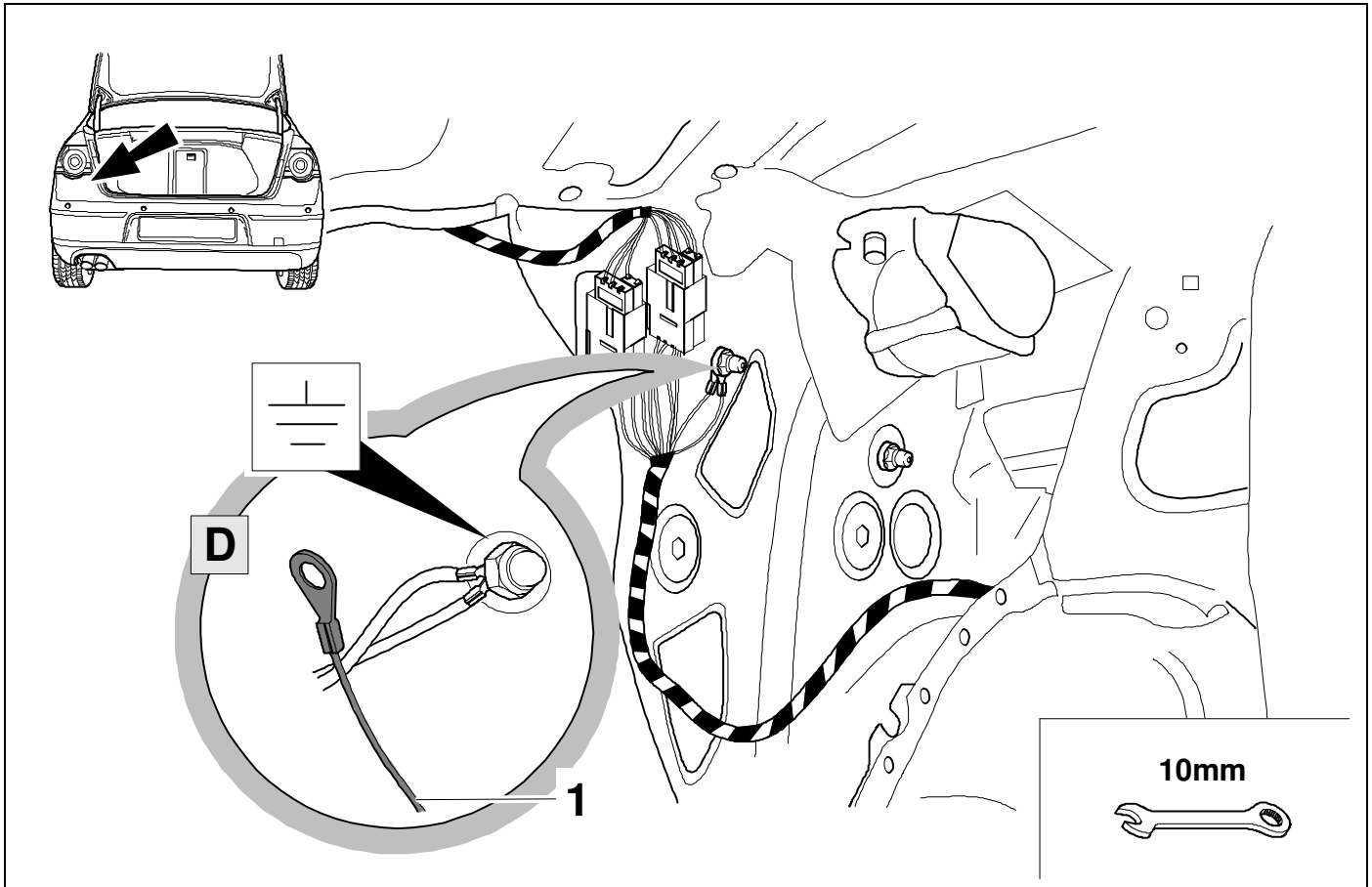

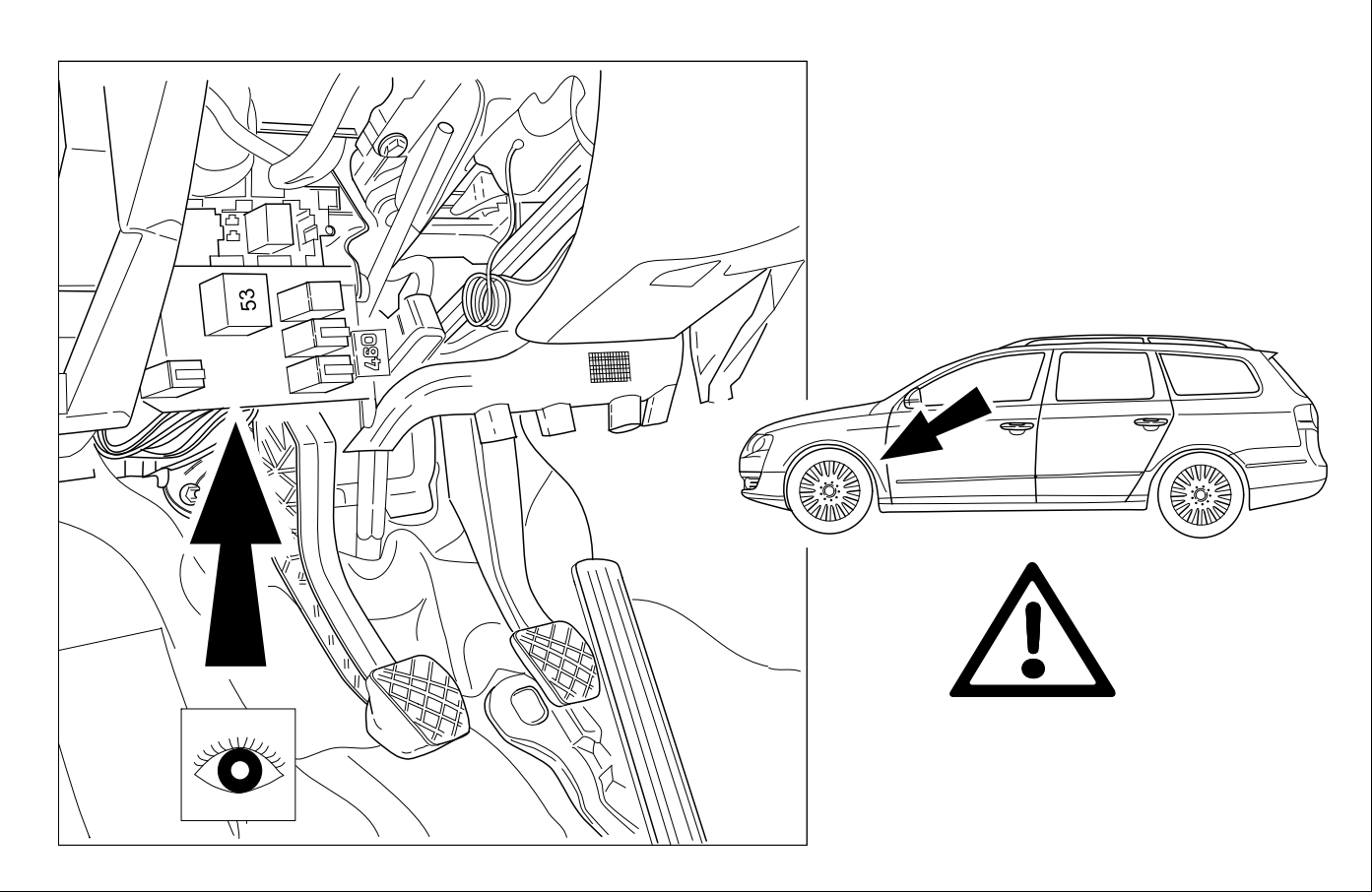
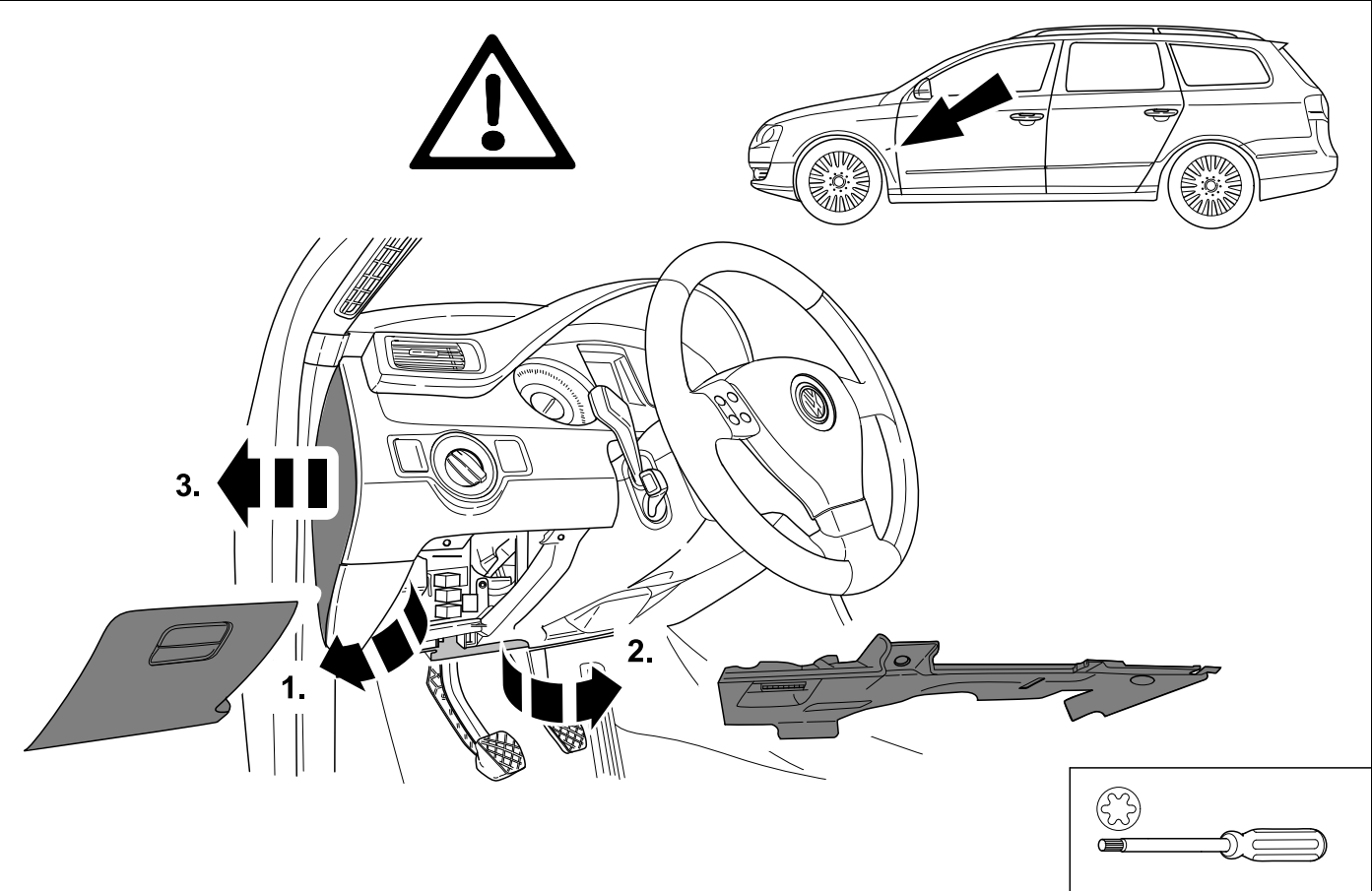

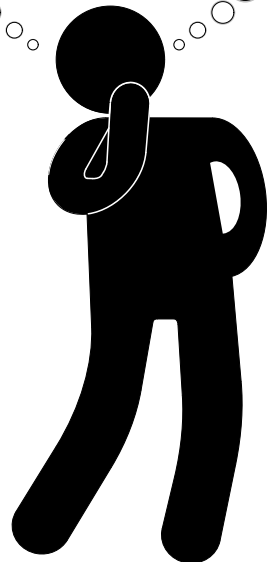
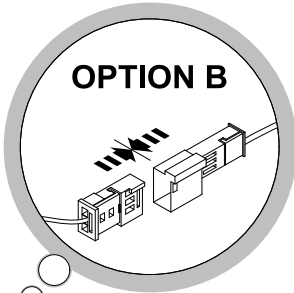
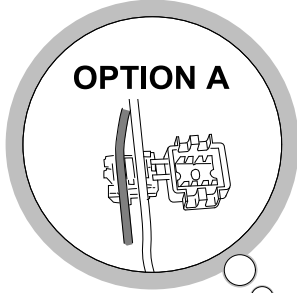

OPTION A

$$\begin{array}{r} \boxed{25} - \boxed{29} \\ + \\ \boxed{35} - \boxed{62} \end{array}$$

OPTION B

$$\begin{array}{r} \boxed{25} \\ + \\ \boxed{30} - \boxed{62} \end{array}$$

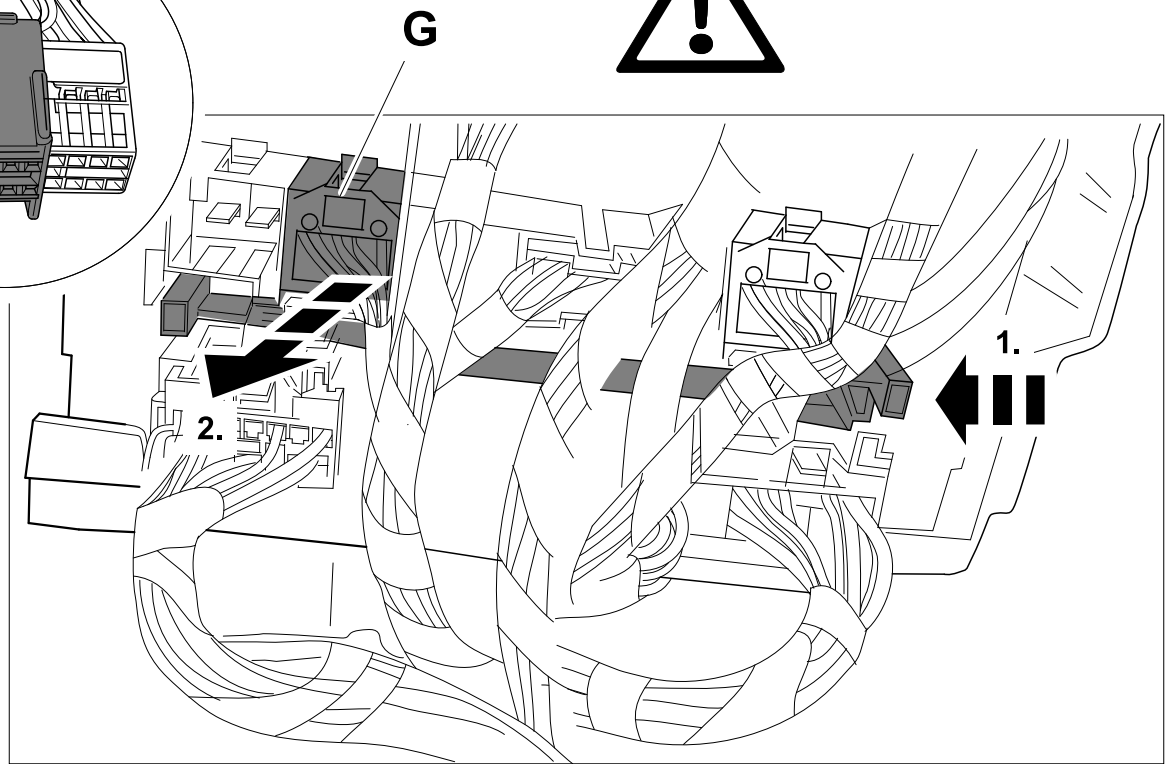
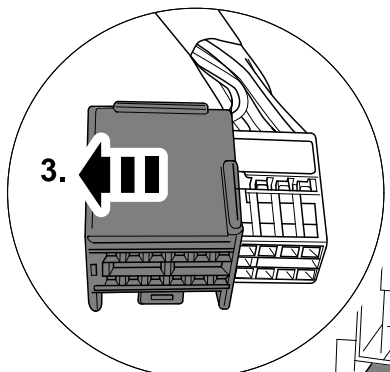

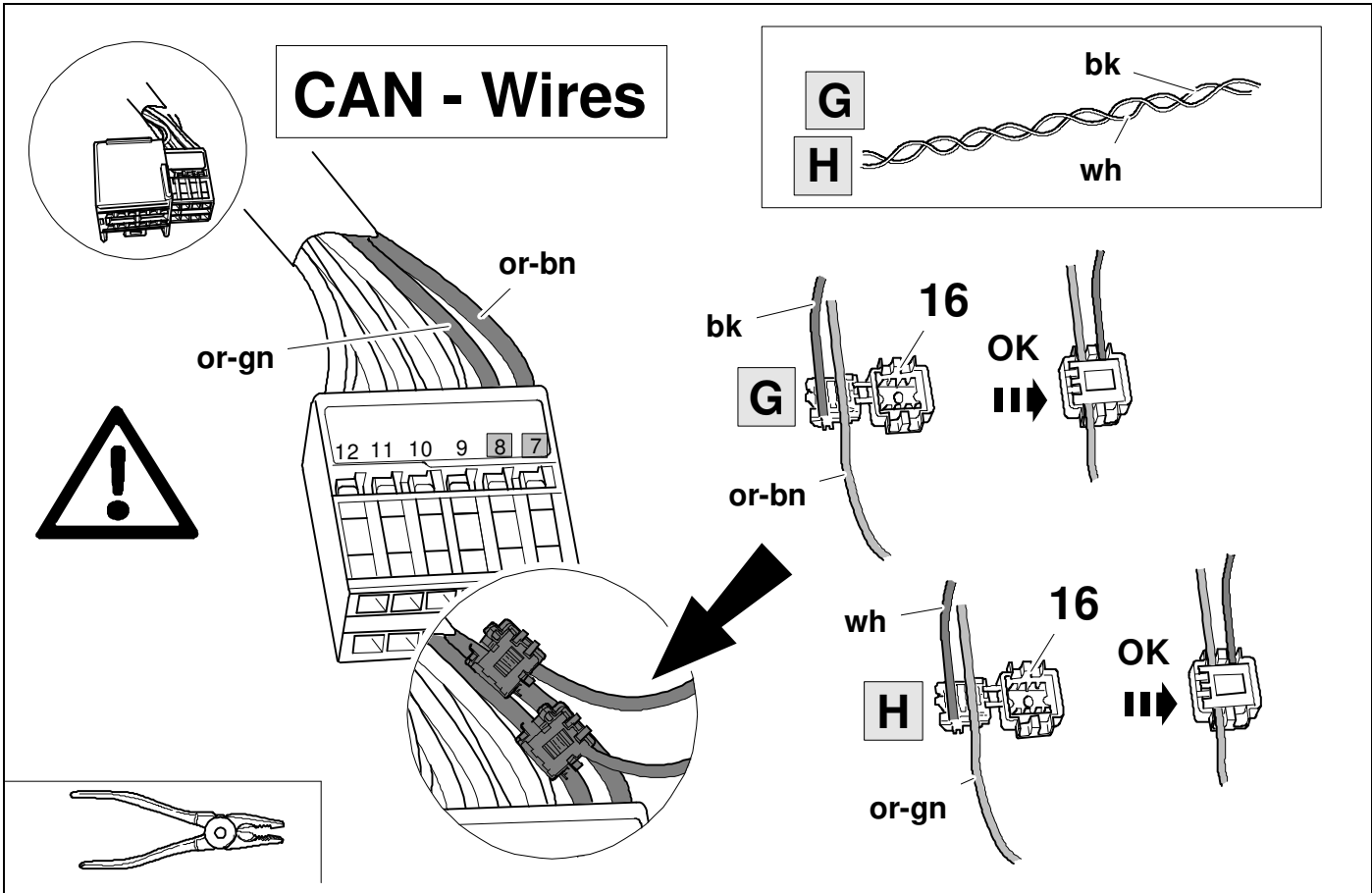
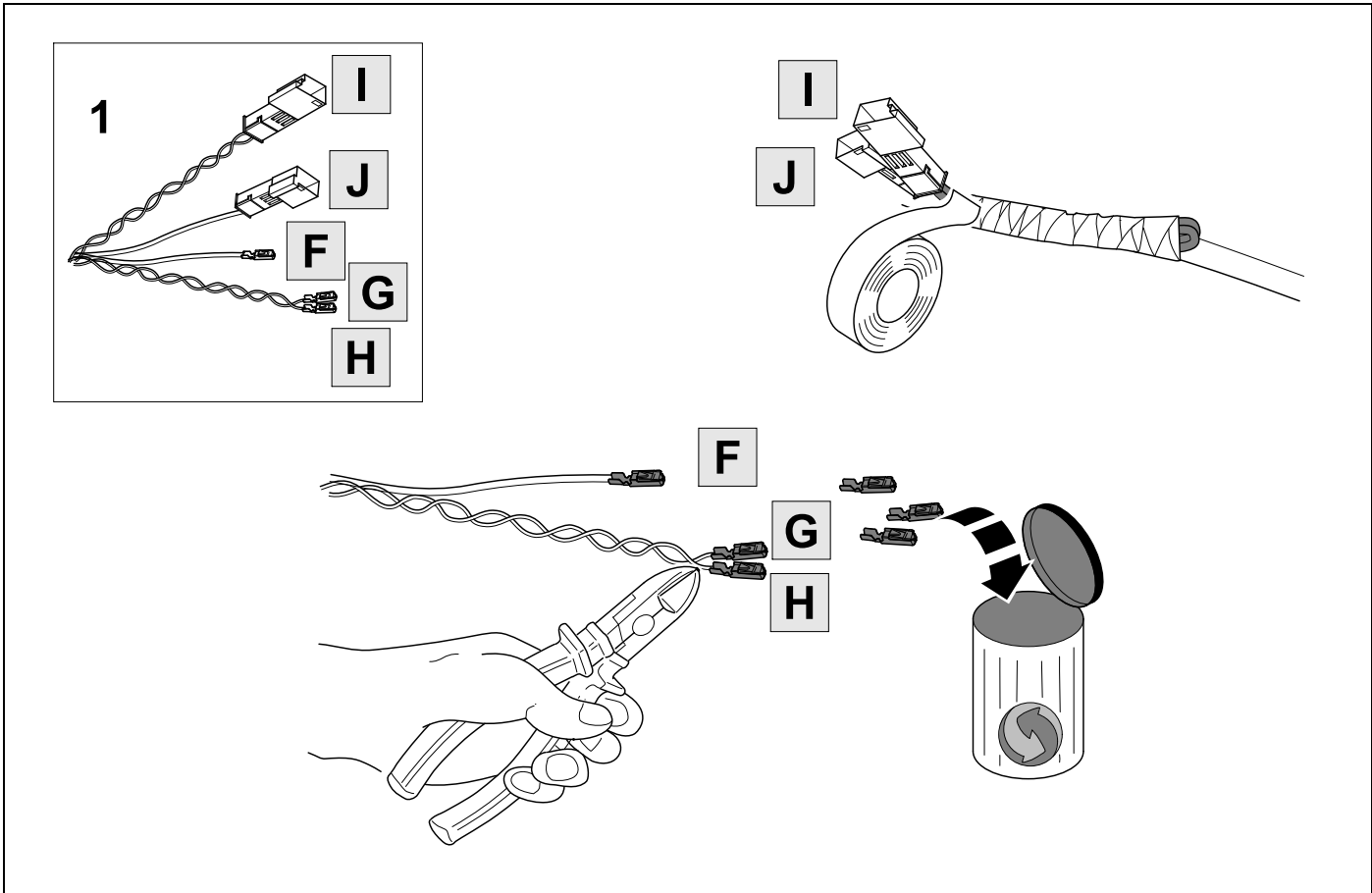

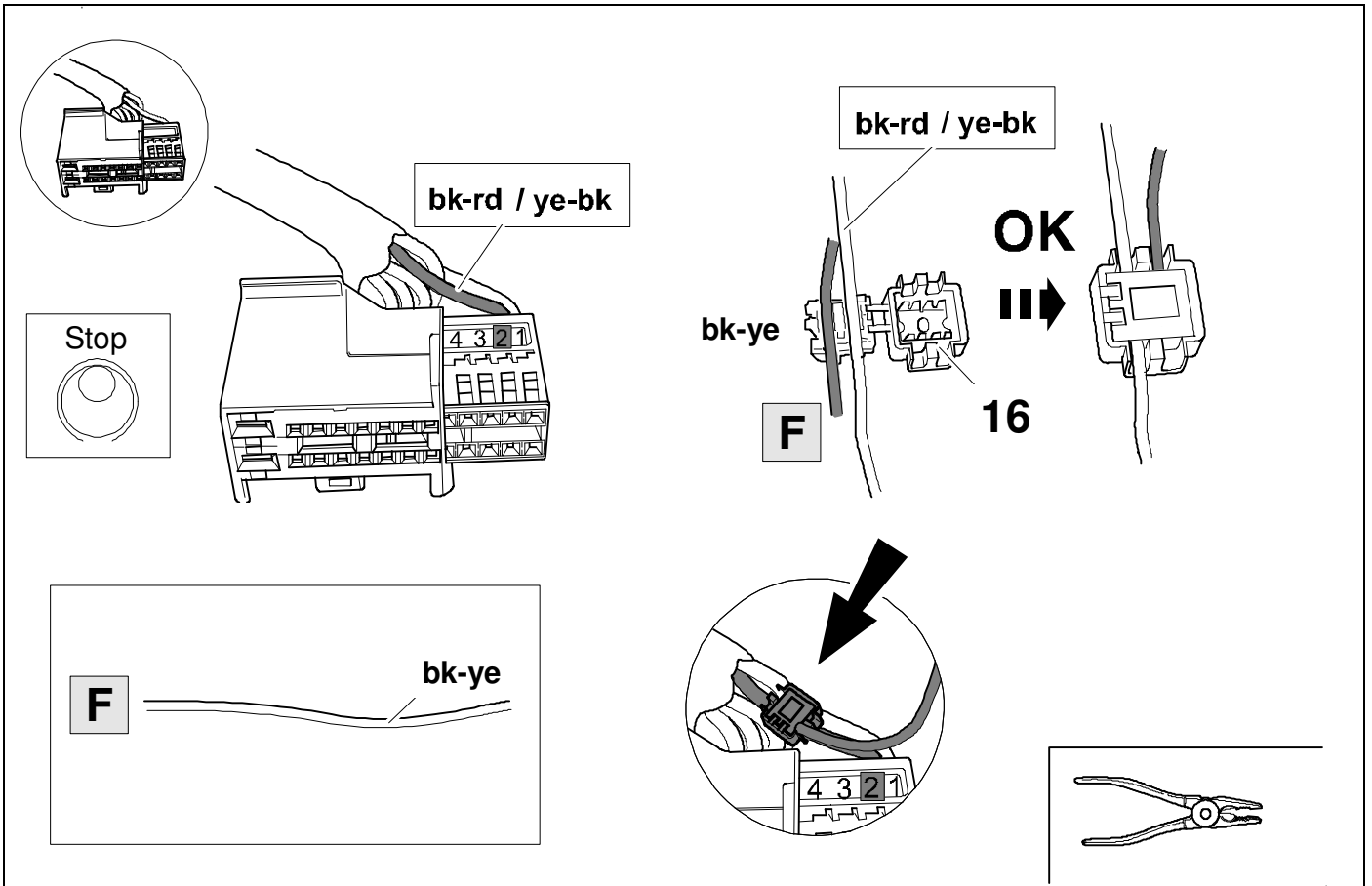
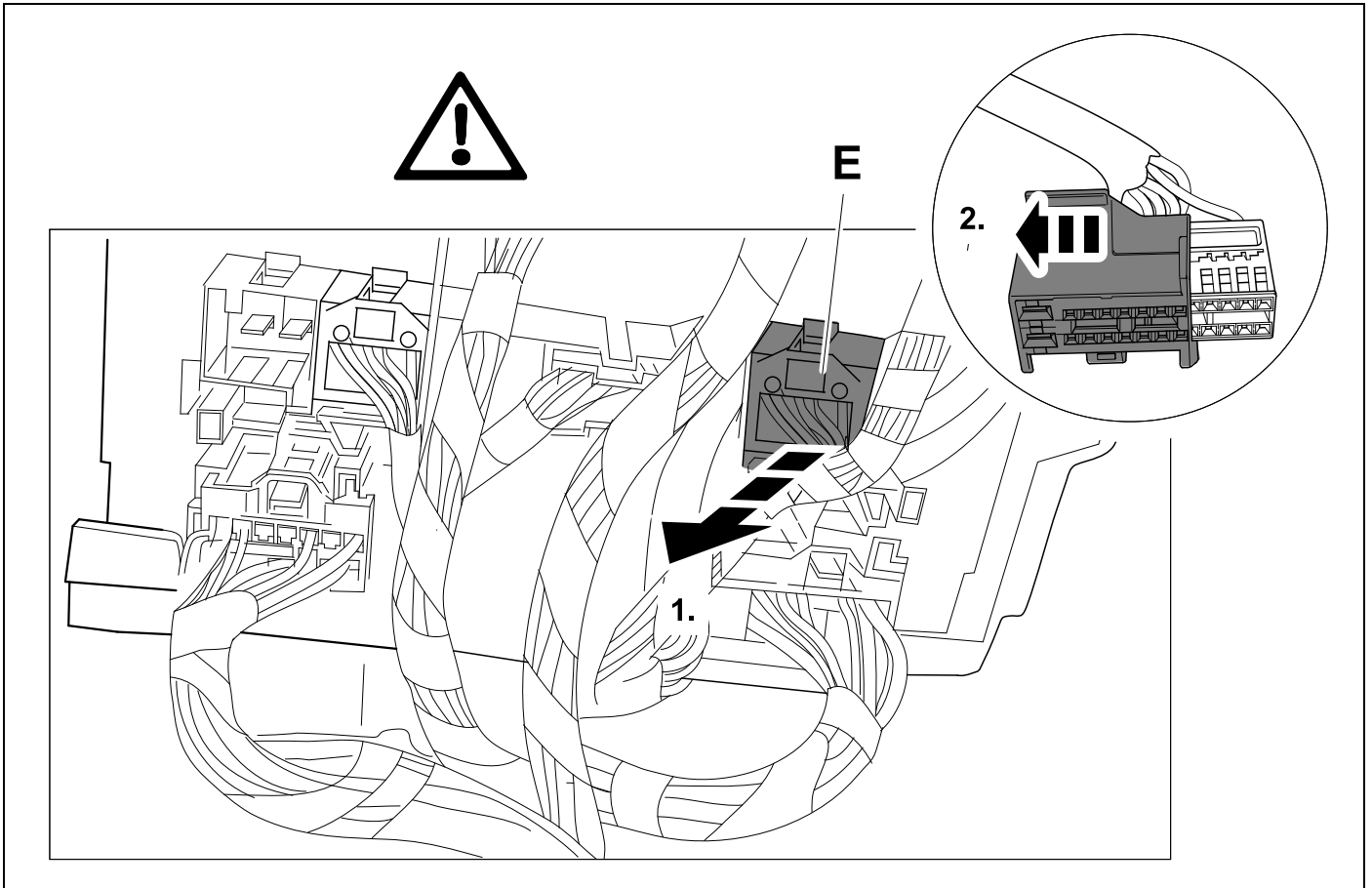

CAN - Wire

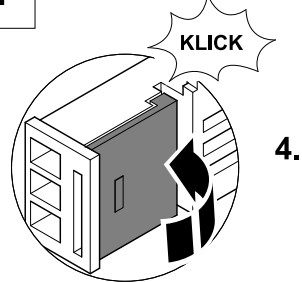
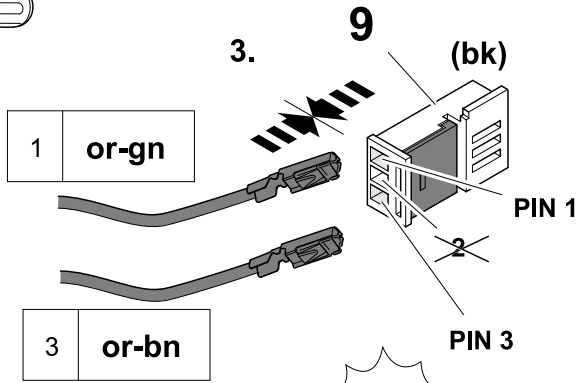
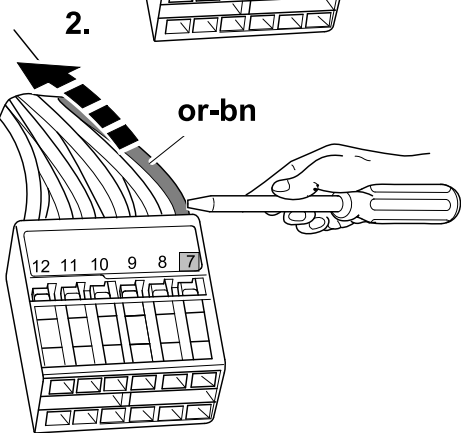
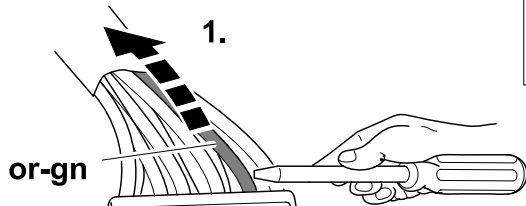
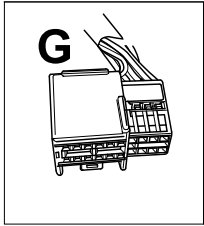

CAN - Wire

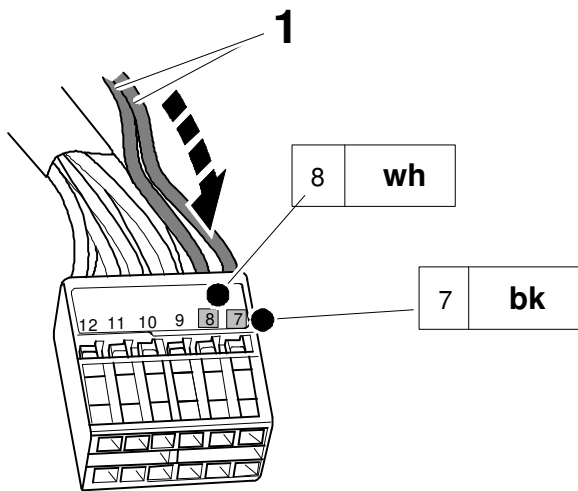
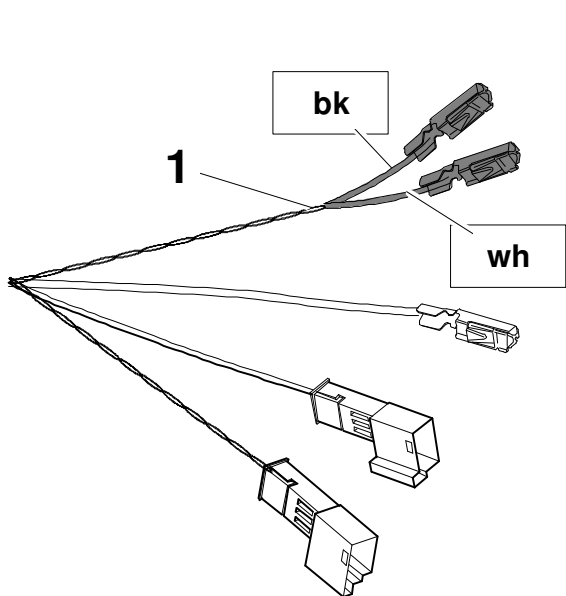

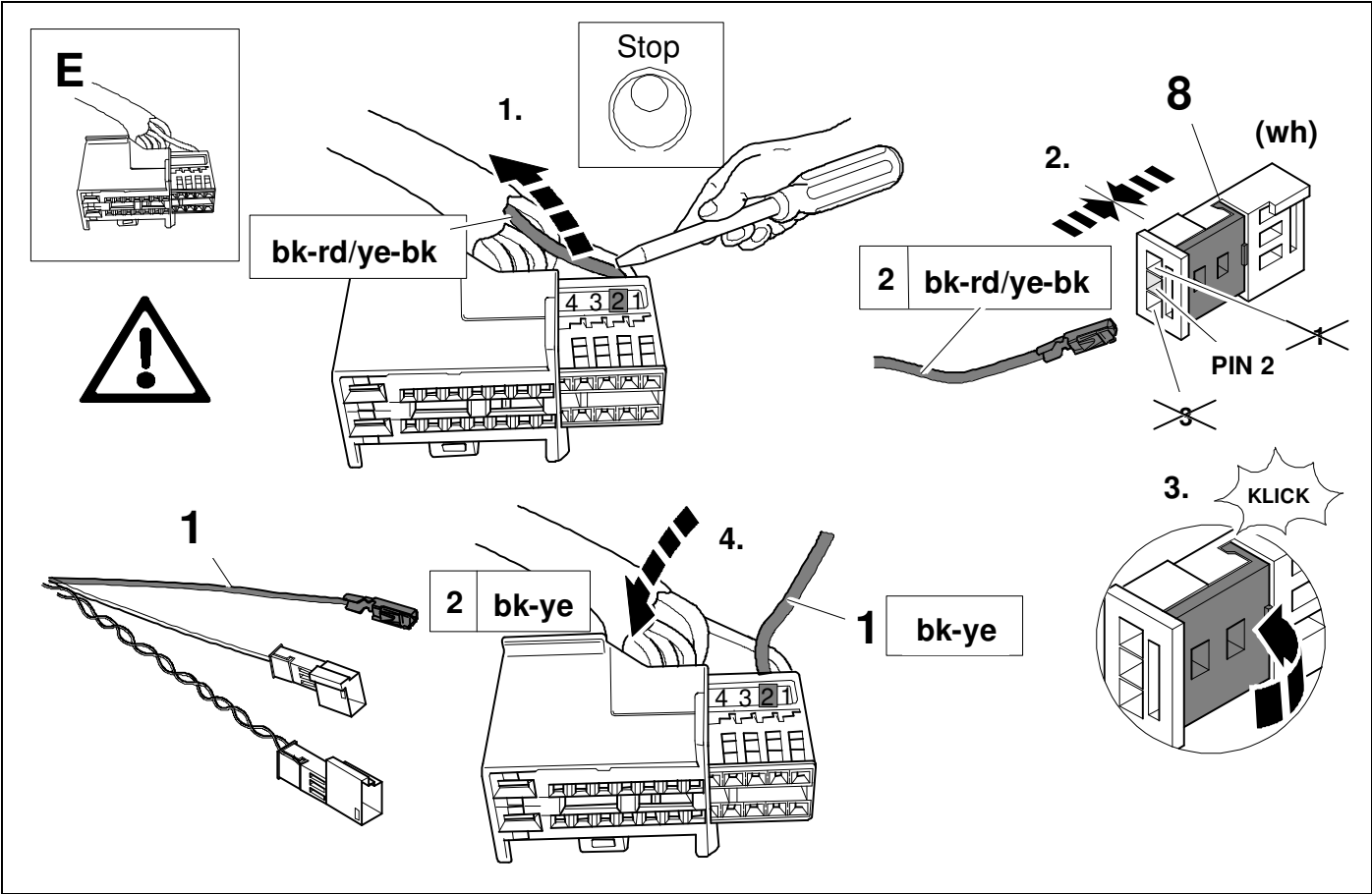
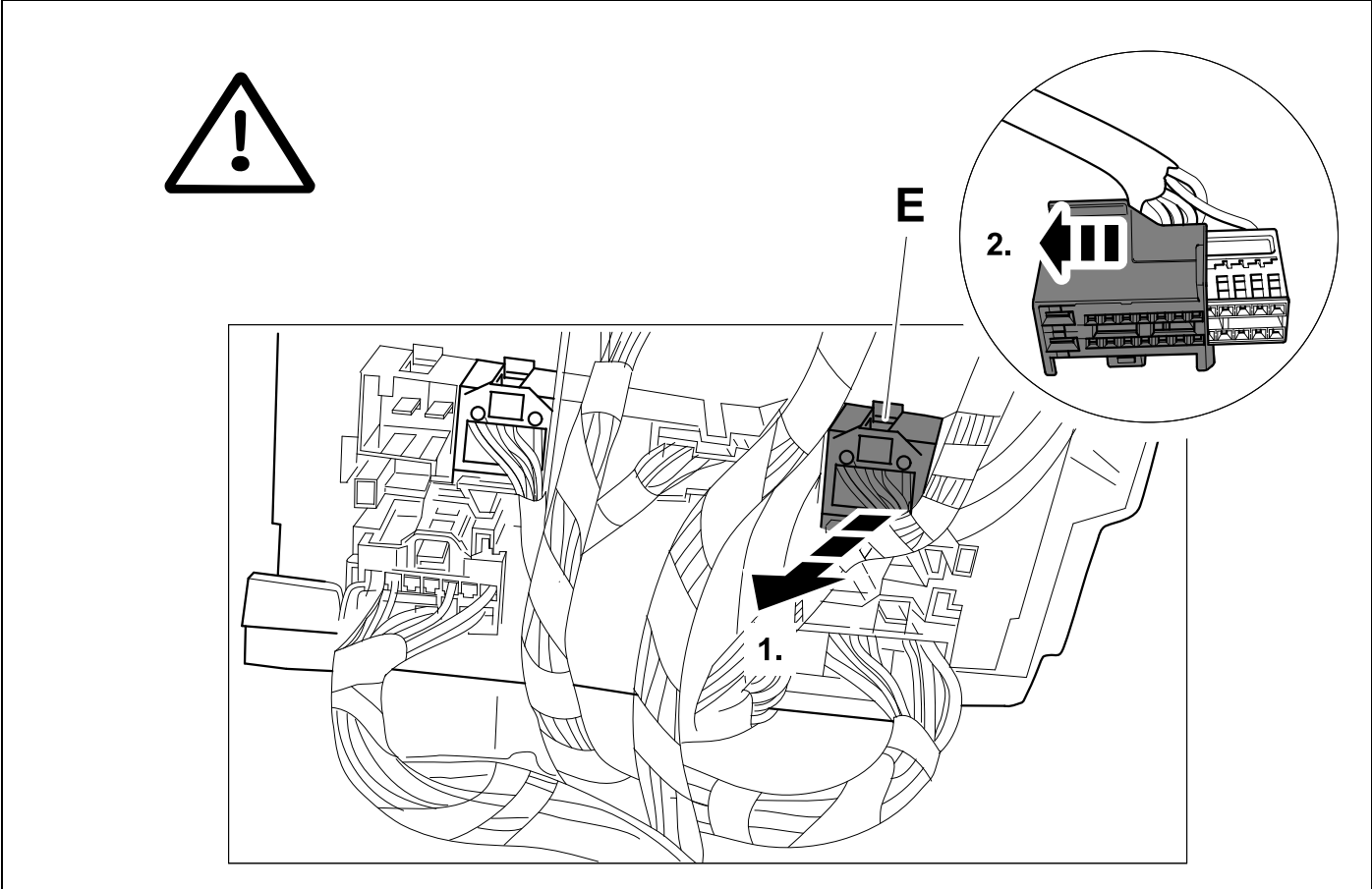

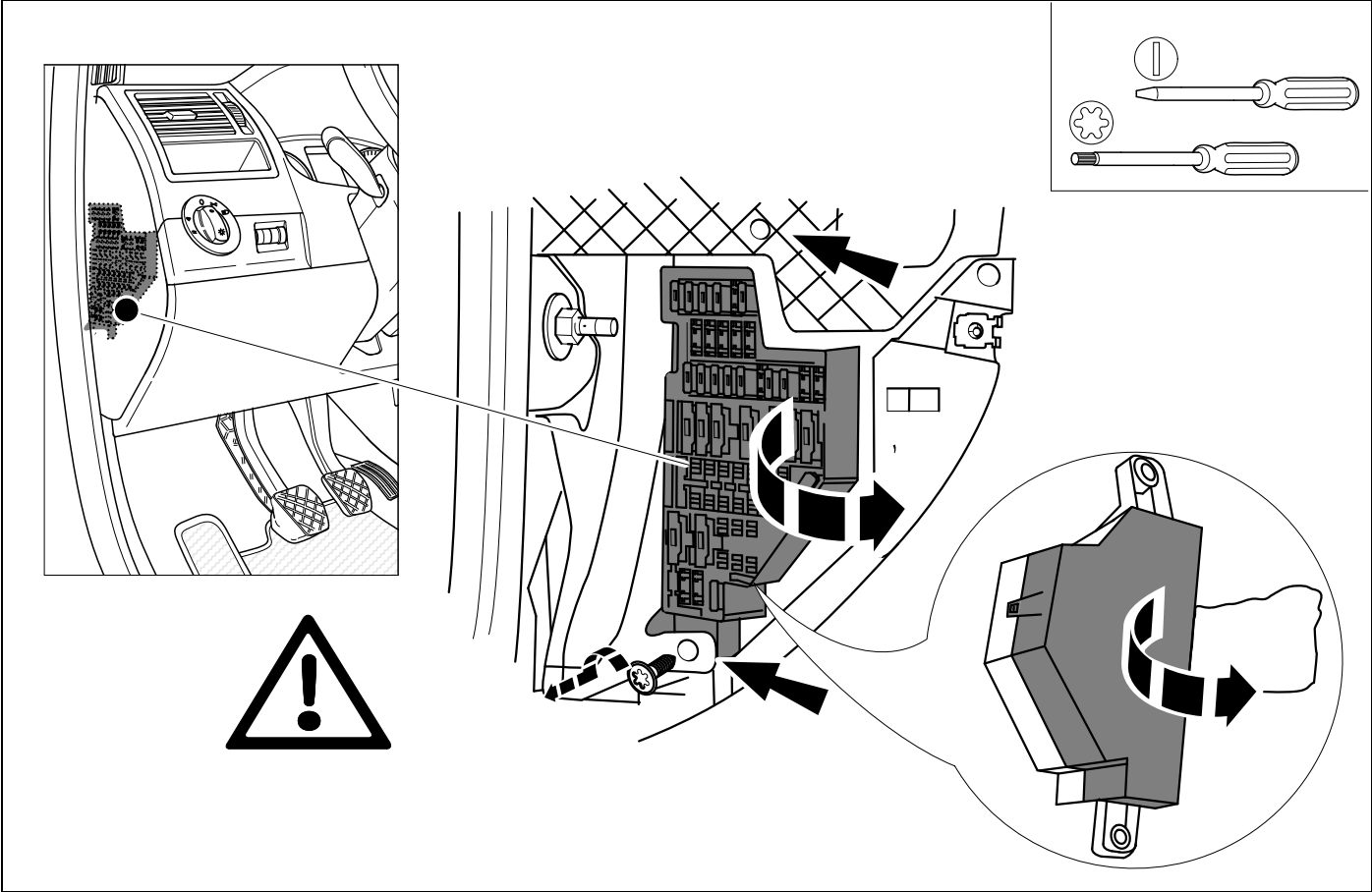
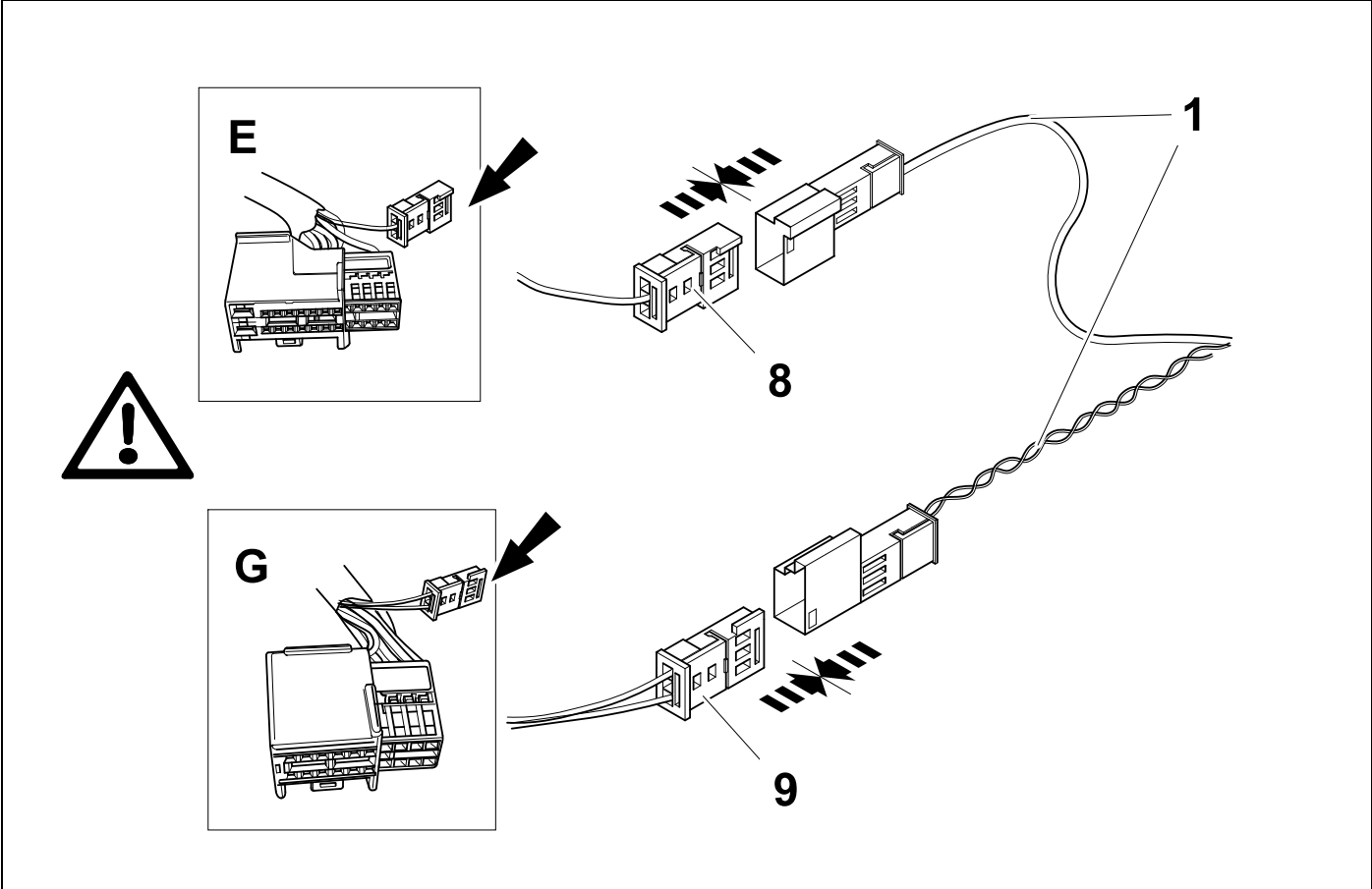

36



Open secondary lock!
Sekundärverriegelung öffnen!

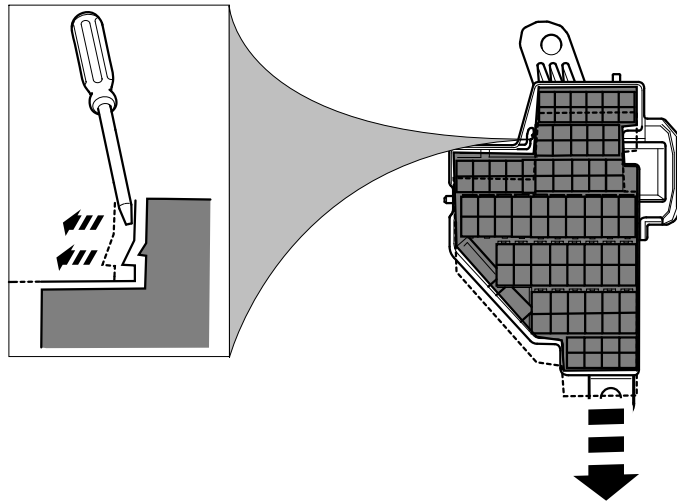

37

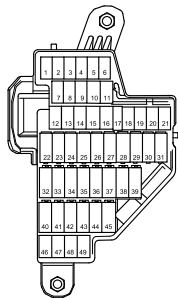

Passat Variant
Passat Limousine
Jetta

OPTION 1

→ 2008
→ 2008
→ 2011



38

41

46

62

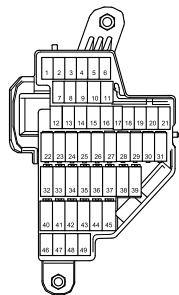

Passat Variant
Passat Limousine
Passat CC

OPTION 2

→ 2009
→ 2009
→ 2008



42

62

OPTION 1

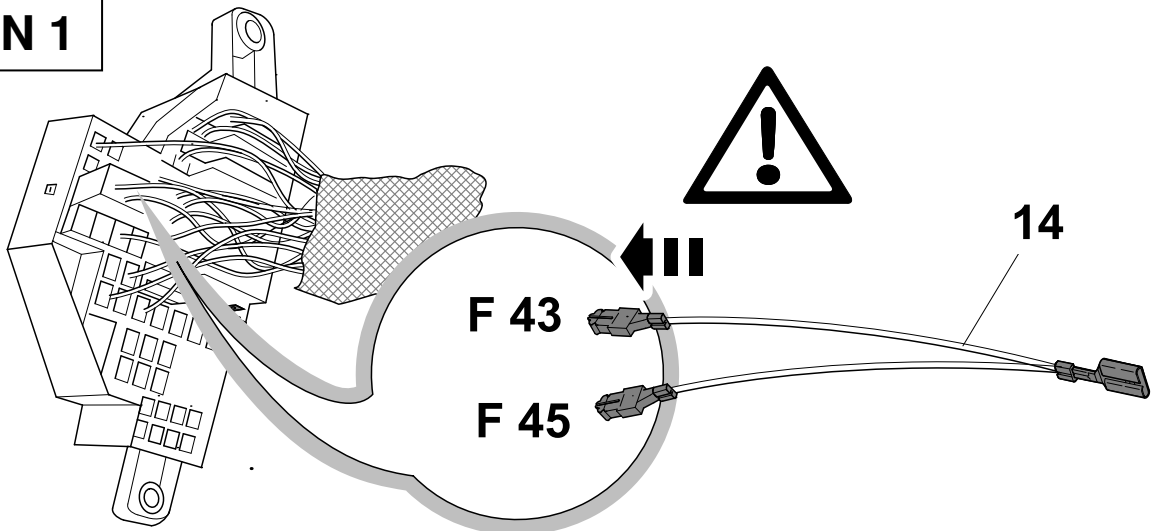

OPTION 1

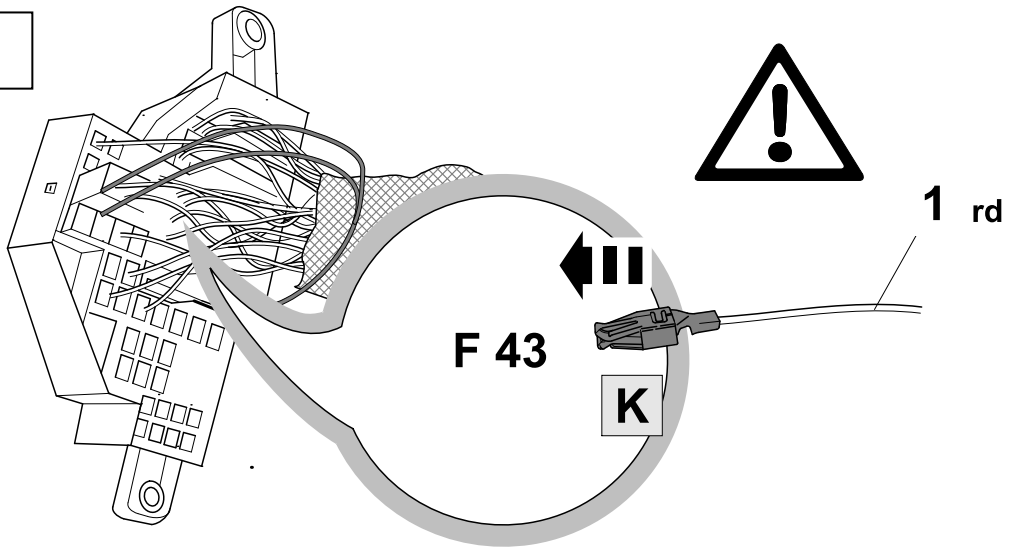

OPTION 1

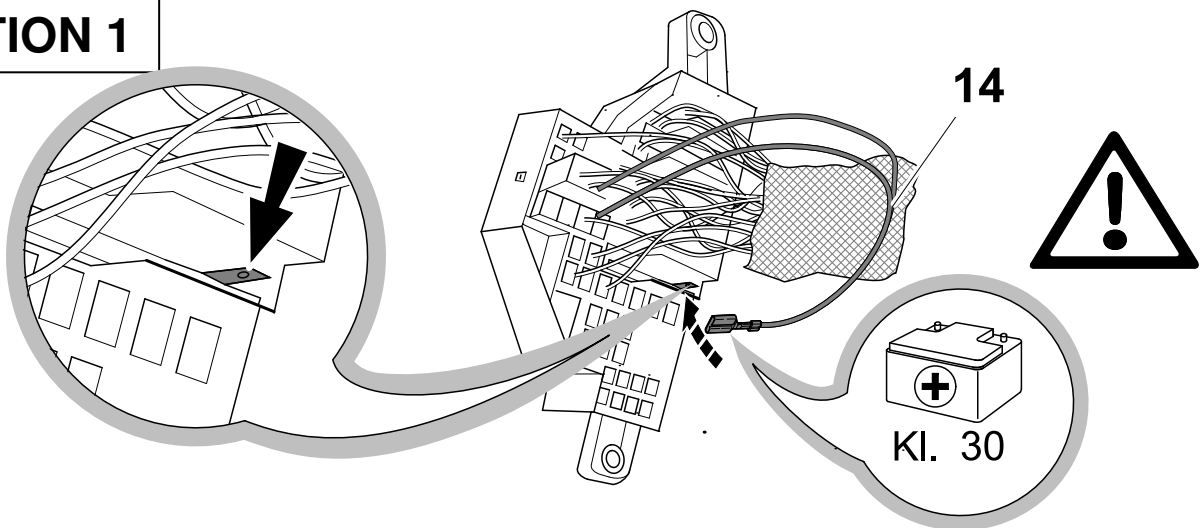

41



58

Variant / Limousine → 2008 / Jetta → 2011

OPTION 1



10
20 A

43

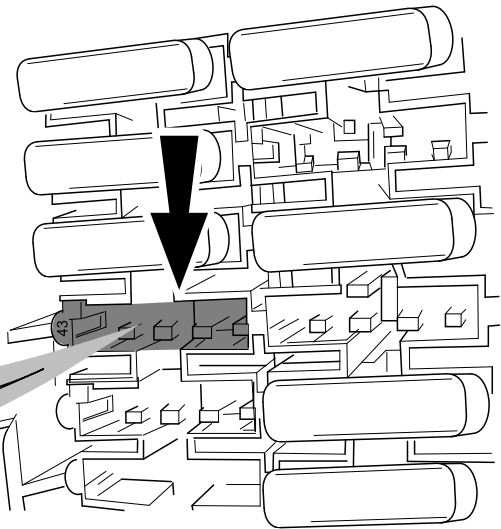

42

Variant / Limousine 2009 → / CC 2008 →

OPTION 2



14

F 23

F 25

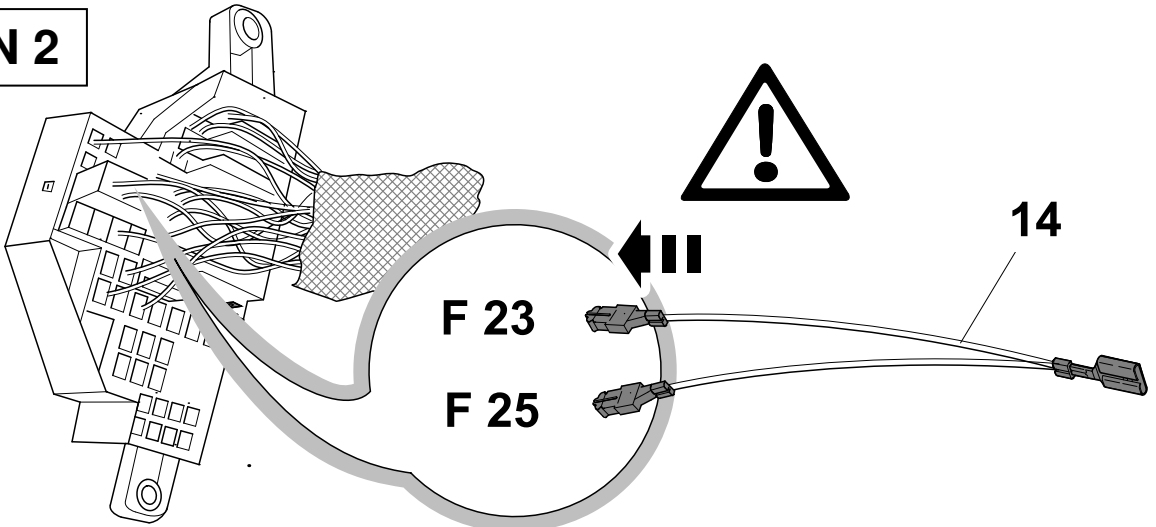

43



15

Variant / Limousine 2009 → / CC 2008 →

OPTION 2



1 rd

F 23

K

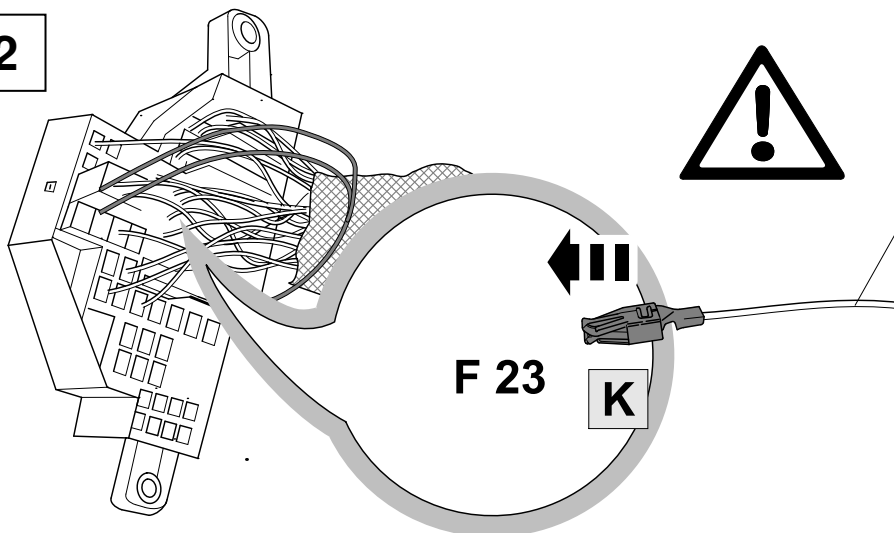

OPTION 2

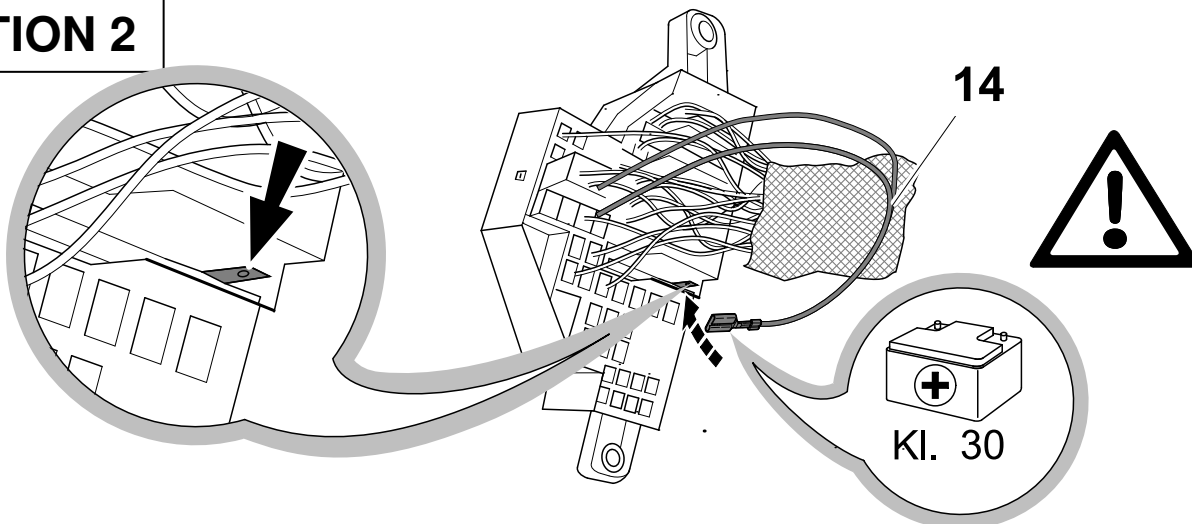

OPTION 2

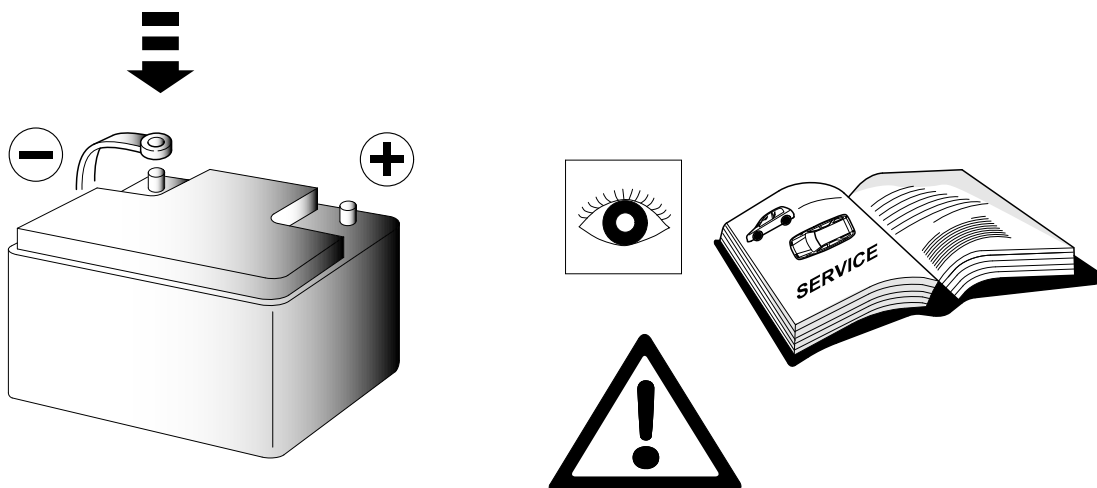
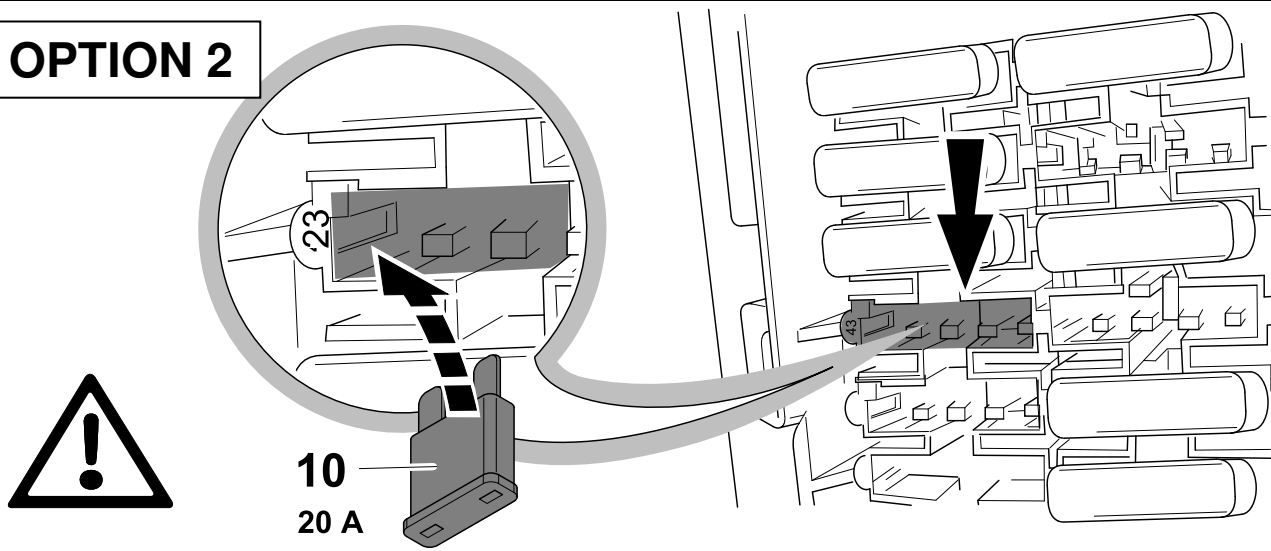

47 CHECK

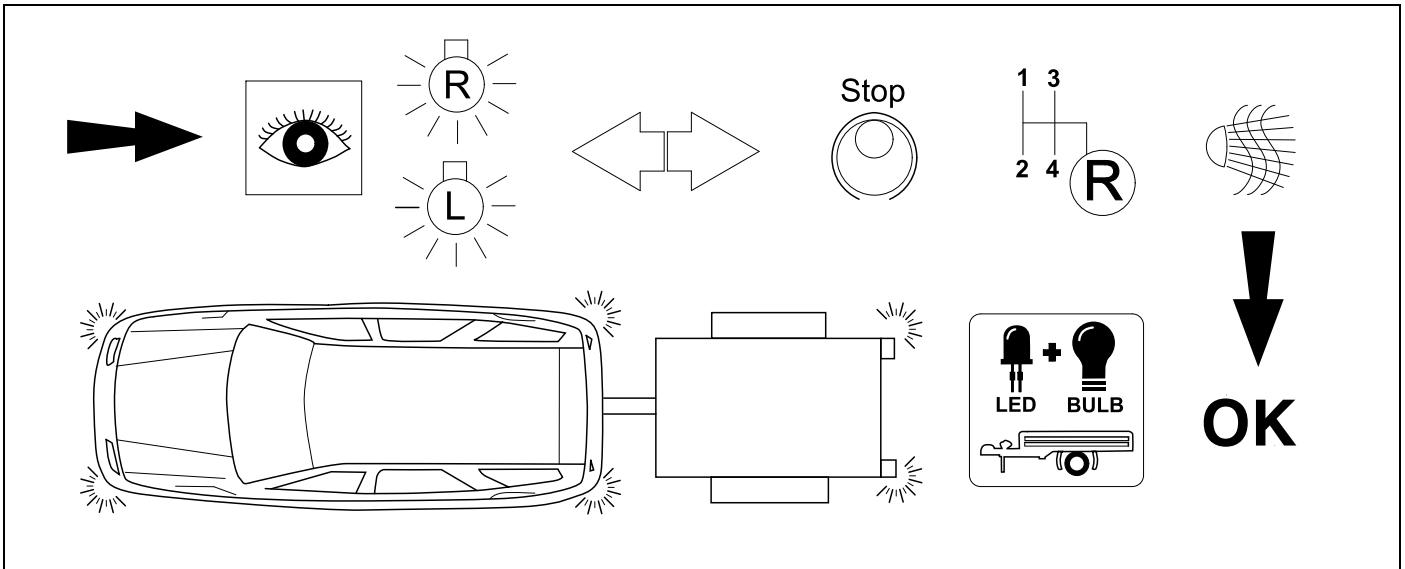

48 OPTIONAL



BRiNK



49 JIFELINE CODING

OPTION 1



Need help programming this wiringkit?

If possible, we provide tips in our manuals on how the vehicle can be coded. It is always possible that more or different coding steps are required for your specific vehicle. That is why we recommend the use of Jifeline.

Jifeline codes your vehicle online with the most up to date knowledge.

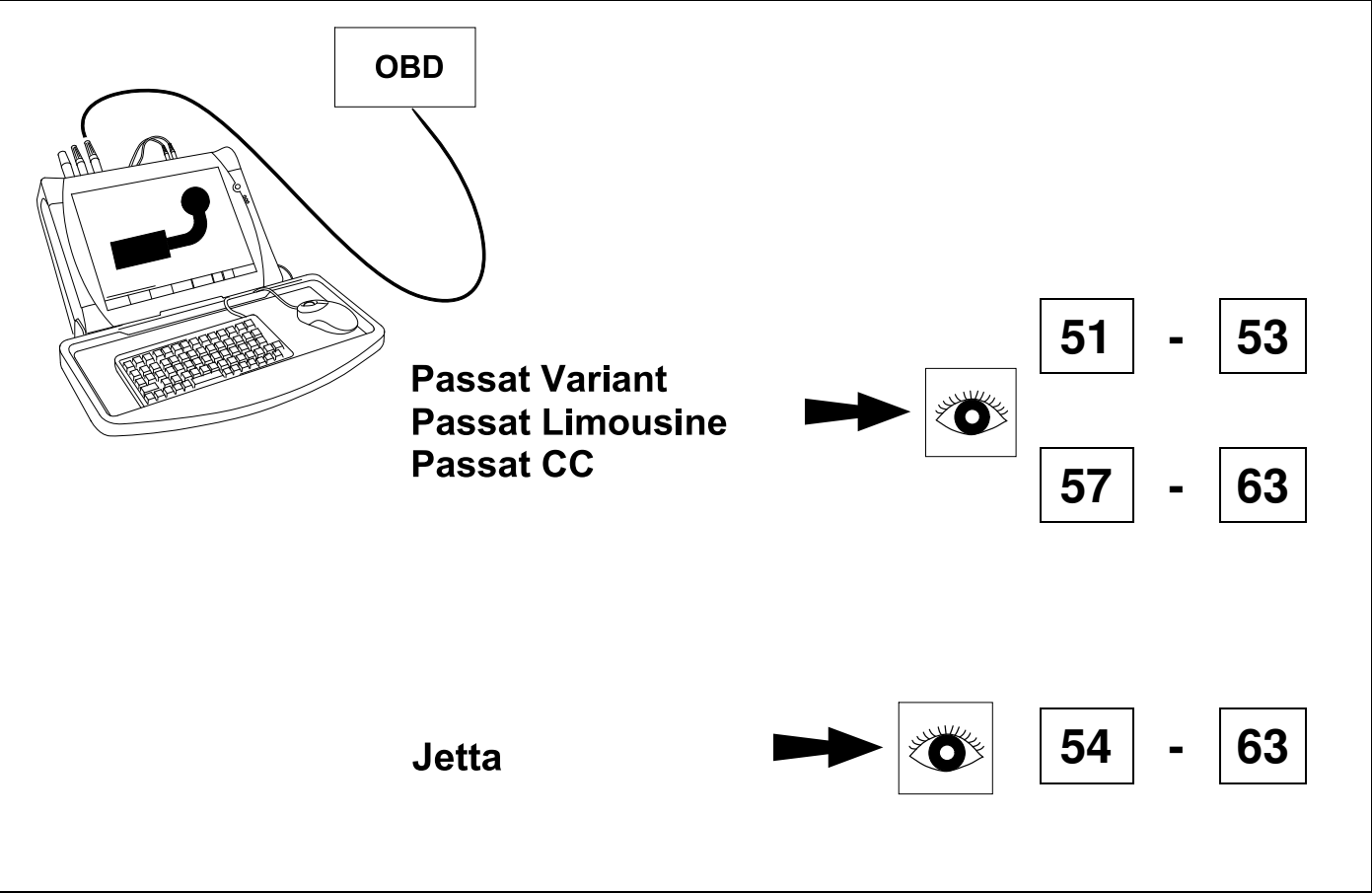

(D)	(GB)
<p>Codierung bitte wie folgt durchführen:</p> <ul style="list-style-type: none"> • Fahrzeug-Eigendiagnose • Gateway-Verbauliste • 19 – Diagnoseinterface für Datenbus • 007-Codierung (Dienst \$1A) \ Lange Codierung lesen / schreiben • 69 – Anhängerfunktion (auf codiert schalten!) <p>Fahrzeuge mit Einparkhilfe</p> <p>Die automatische Deaktivierung der rückwärtigen Einparkhilfe im Anhängerbetrieb wird durch nachfolgende Codierung des Einparkhilfe-Steuergeräts erreicht:</p> <p>Nur Fahrzeuge bis Modelljahr 2007 (MY07):</p> <ul style="list-style-type: none"> • Fahrzeug-Eigendiagnose • Gateway-Verbauliste • 76 – Einparkhilfe • 07 – Steuergerät codieren • Den Wert 10000 zur aktuellen Codierung addieren & neu programmieren <p>Fahrzeuge ab Modelljahr 2008</p> <ul style="list-style-type: none"> • Fahrzeug-Eigendiagnose • Gateway-Verbauliste • 10 - Einparkhilfe II / Parklenkassistent • 008 Codierung (Dienst \$22) • Byte 0 - Bit-Muster xxxxxxx1 (x = die vorhandenen Werte im Eingabefeld übernehmen, dazu Eingabemodus (BIN) einschalten!) • mit OK bestätigen! <p>Fahrzeuge mit Spannungstabilisierung - Nur Fahrzeuge bis Modelljahr 2007 (MY07):</p> <p>Zur Aktivierung der Spannungstabilisierung muss das ESP Steuergerät neu codiert werden! Hierzu lesen Sie bitte die aktuelle Codierzahl des ESP-Steuergeräts mit Hilfe des Service Testers aus und tragen diese in die nachstehende Tabelle ein. Durch Addition der Zahl 16384 erhalten sie die neue Codierzahl. Bitte tragen Sie den neuen Wert in die nachstehende Tabelle ein. Vermerken Sie den Eingriff außerdem im Fahrzeughandbuch unter „1.1 Serviceplan“ - Abschnitt - „Sonstige Eintragungen der Werkstatt“</p>	<p>Please effect coding as follows:</p> <ul style="list-style-type: none"> • Vehicle self-diagnosis • Gateway assembly list • 19 – diagnosis interface for data bus • 007-Coding (service \$1A) \ Read / write • long coding • 69 – trailer function (switch to coded!) <p>Vehicles with park assist systems</p> <p>The automatic deactivation of the rear park assist system in trailer operation will be effected by means of the subsequent coding of the park assist control unit:</p> <p>Only vehicles until model year 07 (MY07)</p> <ul style="list-style-type: none"> • Vehicle self-diagnosis • Gateway assembly list • 76 – park assist system • 07 – code control unit • Add the figure 10000 to the current coding & reprogramme <p>Vehicles from model year 2008 on:</p> <ul style="list-style-type: none"> • Vehicle self-diagnosis • Gateway assembly list • 10 - park assist system II / parallel park assist • 008 Coding (service \$22) • Byte 0 - bit pattern xxxxxxx1 (x = accept the default values in the input field for this purpose activate input mode (BIN) !) • confirm with OK ! <p>Stabilisation of the vehicle / trailer combination - Only vehicles until model year 07 (MY07)</p> <p>To activate the stabilisation of the vehicle/trailer combination, the ESP control unit must be recoded! For this purpose please read the current coding number of the ESP control unit via the service tester (VAS 5051 / 5052) and enter it in the table below. By adding the figure 16384, you will receive the new coding number. Please also enter the new value in the table below. Also note this intervention in the vehicle manual in chapter “1.1 Service schedule“ -“Other entries to be made by the garage personnel“</p>
Codierzahl ESP-Steuergerät	Coding number ESP control unit
Alt	Old
Neu	New
<p>Codierung ESP Steuergerät bitte wie folgt durchführen.</p> <ul style="list-style-type: none"> • Fahrzeug –Eigendiagnose • „03“ Bremsenelektronik • „07“ Steuergerät codieren • Den Wert 16384 zur aktuellen Codierung addieren & neu codieren. <p>Bei Fahrzeugen ab Modelljahr 2008 ist die Freischaltung der Spannungstabilisierung nicht mehr erforderlich!</p> <p>AutoHold - Nur Fahrzeuge bisModelljahr 2007:</p> <p>Zündung aus, Zündschlüssel abziehen, 1Minute warten, Zündung an. Codierung vom Steuergerät der Feststellbremse kontrollieren / ändern</p> <ul style="list-style-type: none"> • Gateway-Verbauliste • 53 Feststellbremse • Fahrzeuge ohne AutoHold-Funktion: Codierzahl 11 • Fahrzeuge mit AutoHold-Funktion: Codierzahl 12 • 07 Steuergerät codieren • Codierzahl entsprechend Fahrzeugausstattung • (mit/ohne Autohold) eingeben 	<p>Please effect coding of the ESP control unit as follows:</p> <ul style="list-style-type: none"> • Vehicle self-diagnosis • Gateway assembly list • 03 – Electronic braking system • 07 – Code control unit • Add the figure 16384 to the current coding & reprogramme <p>The coding of the stabilisation is not needed anymore on vehicles from model year 2008 on!</p> <p>AutoHold - Only vehicles until model year 2007:</p> <p>Switch off ignition, remove ignition key, wait 1 minute, switch on ignition. Check/amend the the code of the parking brake control unit</p> <ul style="list-style-type: none"> • Vehicle self-diagnosis • Gateway assembly list • 53 parking brake • vehicles without Autohold function: code 11 • vehicles with Autohold function: code 12 • 07 code control unit • enter the code according to the vehicle fittings (with/without Autohold)

F	I
<p>Veillez effectuer le codage comme il suit:</p> <ul style="list-style-type: none"> • autodiagnostic du véhicule • liste d'assemblage gateway • 19 – interface de diagnostic pour bus de données • 007-codage (service \$1A) \ lire / écrire uncode long • 69 – mode remorque (commuter à encodé!) <p>Véhicules avec système d'aide au parking</p> <p>L'aide au parking arrière est désactivée automatiquement dans le mode remorque par le codage suivant du dispositif de commande du système d'aide au parking:</p> <p>Seulement pour véhicules jusque année 2007 (MY07):</p> <ul style="list-style-type: none"> • autodiagnostic du véhicule • liste d'assemblage gateway • 76 – aide au parking • 07 – coder le dispositif de commande • additionner la valeur 10000 au code actuel et effectuer un nouveau paramétrage <p>Véhicules à partir de l'année 2008:</p> <ul style="list-style-type: none"> • autodiagnostic du véhicule • liste d'assemblage gateway • 10 - système d'aide au parking II / • parallel park assist • 008 Codage (service \$22) • Modèle Byte 0 bits xxxxxxx1 (x = reprendre les valeurs dans le champ de saisie et allumer le mode saisie (BIN)!) • Confirmer en appuyant sur OK <p>Stabilisation de l'attelage – Seulement pour véhicules jusque année 2007:</p> <p>Pour activer la stabilisation de l'attelage, le dispositif de commande ESP doit être encodé à nouveau! A cet effet, veuillez lire le code actuel du dispositif de commande ESP à l'aide du testeur service (VAS 5051 / 5052) et enregistrez-le dans le tableau suivant. Ensuite, calculez le nouveau code en additionnant le chiffre 16384. Veuillez également enregistrer le nouveau code dans le tableau suivant.</p> <p>De plus, veuillez noter cette intervention dans le manuel de voiture sous «1.1 Plan de service»-section-«Autres remarques du garage»</p>	<p>Si prega di eseguire la codifica come segue:</p> <ul style="list-style-type: none"> • Autodiagnosi del veicolo • Lista del Gateway • 19 – Interfaccia di diagnosi per il data bus • 007-codifica (servizio \$1A) \ Lettura e scrittura di codici lunghi • 69 – Funzione rimorchio (commutare su codificato!) <p>Veicoli con sensori di parcheggio</p> <p>La disattivazione automatica dei sensori di parcheggio posteriori quando è attaccato un rimorchio si ottiene attraverso la seguente programmazione della centralina di controllo dei sensori:</p> <p>Solamente per modelli fino al 2007 (MY07):</p> <ul style="list-style-type: none"> • Autodiagnosi del veicolo • Lista d'installazione Gateway • 76 – Sensori di parcheggio • 07 – Codificare la centralina di controllo • Aggiungere il valore 10000 al codice attuale e riprogrammare <p>Modelli a partire dall'anno 2008:</p> <ul style="list-style-type: none"> • Autodiagnosi del veicolo • Lista del Gateway • 10 - sensori di parcheggio II / parallel • park assist • 008 Codifica (servizio \$22) • Byte 0 – modello Bit xxxxxxx1 (x = applicare i valori disponibili nel campo di immissione, attivando il modo di immissione (BIN)!) • Confermare con OK! <p>Stabilizzazione del rimorchio-Solamente per modelli fino al 2007:</p> <p>Per attivare la stabilizzazione del rimorchio, la centralina di controllo del sistema ESP deve essere riprogrammata! A questo proposito, si prega di leggere il codice attuale della centralina di controllo ESP con il tester di manutenzione (VAS 5051 / 5052) e di riportarlo nella tabella seguente. Il nuovo codice si ottiene aggiungendo il numero 16384! Si prega di scrivere anche il nuovo valore nella tabella, e di annotare l'intervento anche nel libretto del veicolo sotto „1.1. Piano di manutenzione“, sezione „ulteriori annotazioni dell'officina“</p>
Code du dispositif de commande ESP	Codice della centralina ESP
Ancien	Vecchio
Nouveau	Nuovo
<p>Veillez effectuer le codage du dispositif de commande ESP comme il suit:</p> <ul style="list-style-type: none"> • autodiagnostic du véhicule • liste d'assemblage gateway • 03 – électronique des freins • 07 – encoder le dispositif de commande • additionner la valeur 16384 au code actuel et effectuer un nouveau paramétrage <p>Il ne faut pas coder la stabilisation de l'attelage des véhicules à partir de l'année 2008!</p> <p>AutoHold - Seulement pour véhicules jusque année 2007:</p> <p>Couper le contact, retirer la clé de contact, attendre 1 minute, mettre le contact. Contrôler/modifier le codage de la central de commande du frein de stationnement</p> <ul style="list-style-type: none"> • Autodiagnostic du véhicule • liste d'assemblage gateway • 53 frein de stationnement • Véhicules sans fonction AutoHold: code 11 • Véhicules avec fonction AutoHold: code 12 • 07 Coder la centrale de commande • Entrer le code correspondant à • l'équipement du véhicule (avec/sans AutoHold) 	<p>Si prega di seguire la codifica della centralina ESP come segue:</p> <ul style="list-style-type: none"> • Autodiagnosi del veicolo • Lista del Gateway • 03 – Elettronica dell'impianto freni • 07 – Codificare la centralina di controllo • Aggiungere il valore 16384 al codice attuale e riprogrammare <p>I modelli a partire dall'anno 2008 non hanno bisogno di una codifica per la stabilizzazione del rimorchio!</p> <p>AutoHold - Solamente per modelli fino al 07:</p> <p>Spegnere l'accensione, estrarre la chiave, attendere 1 minuto, accendere l'accensione. Controllare/ modificare la codifica della centralina del freno di stazionamento</p> <ul style="list-style-type: none"> • autodiagnosi del veicolo • Lista del Gateway • freno di stazionamento • veicoli senza funzione AutoHold: codice 11 • veicoli con funzione AutoHold: codice 12 • 07 codifica della centralina • inserire il codice in base all'allestimento del veicolo (con/senza AutoHold)

NL	E
<p>Gelieve codering als volgt door te voeren:</p> <ul style="list-style-type: none"> Eigen diagnose voertuig Gateway-inbouwwijst 19 – diagnose-interface für gegenvensinvoerbus 007-Codering (dienst \$1A) \ Lange codering lezen/schrijven 69 – aanhangwagenfunctie (op “Gecodeerd” schakelen!) <p>Voertuigen met parkeerhulp</p> <p>Bij voertuigen met parkeerhulp dient de regeleenheid van de parkeerhulp als volgt te worden gecodeerd:</p> <p>Uitsluitend voertuigen tot modeljaar 07 (MY07):</p> <ul style="list-style-type: none"> Zelfdiagnose voertuig Gateway-inbouwwijst 76 - Parkeerhulp 07 - Regeleenheid coderen De waarde van 10000 bij de actuele code optellen & nieuw programmeren <p>Voertuigen vanaf het modeljaar 2008:</p> <ul style="list-style-type: none"> Eigen diagnose voertuig Gateway-inbouwwijst 10 - parkeerhulp II / Park Assist 008 Codering (dienst \$22) Byte 0 - bitpatroon xxxxxxx1 (x = de aanwezige waarden in het invoerveld overnemen, hiervoor invoermodus (BIN) inschakelen!) met OK bevestigen! <p>Stabilisatie van aanhangwagencombinatie - Uitsluitend voertuigen tot modeljaar 2007:</p> <p>Ter activering van de aanhangwagencombinatie moet het ESP-besturingsapparaat opnieuw worden gecodeerd! Lees hiervoor het actuele codeergetal van het ESPbesturingsapparaat uit met behulp van de servicetester (VAS 5051 / 5052) en noteer dit in de onderstaande tabel. Door optelling van het getal 16384 krijgt u het nieuwe codeergetal. Noteer de nieuwe waarde eveneens in de onderstaande tabel. Maak eveneens een notitie van de ingreep in het voertuighandboek bij “1.1 Serviceschema” – paragraaf -“Overige vermeldingen van de werkplaats“</p>	<p>Codificar del siguiente modo:</p> <ul style="list-style-type: none"> Autodiagnóstico del vehículo Lista Gateway 19 - Interfaz de diagnóstico para bus de datos 007-Codificación (servicio \$1A) \ Leer / escribir la codificación larga 69 - Función del remolque (codificación) <p>Vehículos con sistema de ayuda para el aparcamiento</p> <p>En vehículos con sistema de ayuda para el aparcamiento (PDC) se debe codificar la unidad de control PDC del siguiente modo:</p> <p>Sólo vehículos hasta el modelo del año 07 (MY07):</p> <ul style="list-style-type: none"> Autodiagnóstico del vehículo Lista Gateway 76 - Sistema de ayuda para el aparcamiento 07 - Codificar la unidad de control Adicionar el valor 10000 al código actual y reprogramar <p>Vehículos a partir del año 2008:</p> <ul style="list-style-type: none"> Autodiagnóstico vehículo Lista Gateway 10 - ayuda al aparcamiento II / parallel park assist 008 Codificación (servicio \$22) Byte tipo 0 bits xxxxxxx1 (x = introducir los valores existentes en el campo de entrada, ¡activar al respecto el modo de introducción (BIN)!) ¡Confirmar con OK! <p>Estabilización del tiro - Sólo vehículos hasta el modelo del año 2007:</p> <p>¡Para activar la estabilización del tiro es necesario codificar el regulador ESP de nuevo! Al respecto debe hacer lectura del número de codificación actual del regulador ESP con ayuda del comprobador de servicio (VAS 5051 / 5052) y registrarlo en la tabla que figura a continuación. Sumando el número 16384, obtendrá el nuevo número de codificación. Por favor, registre también el valor nuevo en la tabla que figura a continuación. Además, deberá anotar esta intervención en el manual del vehículo bajo ¡¡“1.1 Plano de servicio” - apartado - “Otras anotaciones del taller“!!</p>
ESP-besturingsapparaat	Número de codificación regulador ESP
Oud	Viejo
Nieuw	Nuevo
<p>Codering ESP-besturingsapparaat als volgt uitvoeren a.u.b.:</p> <ul style="list-style-type: none"> Zelfdiagnose voertuig Gateway-inbouwwijst 03 - Elektronisch remsysteem 07 - Regeleenheid coderen De waarde van 16384 bij de actuele code optellen & nieuw programmeren <p>Bij voertuigen vanaf het modeljaar 2008 de vrijshakeling van de stabilisatie van de aanhangwagencombinatie niet meer nodig!</p> <p>AutoHold - Uitsluitend voertuigen tot modeljaar 2007:</p> <p>Contact uit, contactsleutel uitnemen, 1 minuut wachten, contact aan. Codering van de regeleenheid van de parkeerrem controleren / wijzigen.</p> <ul style="list-style-type: none"> Zelfdiagnose voertuig Gateway-inbouwwijst 53 - Parkeerrem Voertuigen zonder AutoHold-functie: codegetal 11 Voertuigen met AutoHold-functie: codegetal 12 07 - Regeleenheid coderen Codegetal overeenkomstig voertuiguitrusting, (met/zonder AutoHold) invoeren 	<p>Rogamos llevar a cabo la codificación del regulador ESP de la siguiente manera:</p> <ul style="list-style-type: none"> Autodiagnóstico del vehículo Lista Gateway 03 - Sistema electrónico de frenado 07 - Codificar la unidad de control Adicionar el valor 16384 al código actual y reprogramar <p>¡Los vehículos a partir del año 2008 no hacen que la necesidad de una codificación de la estabilización del remolque!</p> <p>AutoHold - Sólo vehículos hasta el modelo del año 2007:</p> <p>Desconectar el encendido, quitar la llave de contacto, esperar 1 minuto, conectar encendido. Comprobar / modificar la codificación de la unidad de control del freno de mano:</p> <ul style="list-style-type: none"> Autodiagnóstico del vehículo Lista Gateway 53 - Freno de mano Vehículos sin función AutoHold: código 11 Vehículos con función AutoHold: código 12 07 - Codificar la unidad de control Introducir el código del vehículo correspondiente al equipamiento del mismo

D	GB
<p>Codieren des Gatewaysteuergerätes</p> <p>Das fahrzeugseitige Gateway muss wie nachfolgend beschrieben, unter dem Punkt Eigendiagnose, mit einem VAS-Tester zur Funktionserweiterung Anhängervorrichtung codiert werden:</p> <ul style="list-style-type: none"> • Fahrzeug-Eigendiagnose • Gateway-Verbauliste • 19 – Diagnoseinterface für Datenbus • 007-Codierung (Dienst \$1A) \ Lange Codierung lesen / schreiben • 69 – Anhängerfunktion (auf codiert schalten!) <p>Codieren des Einparkhilfesteuergerätes</p> <p>Nach erfolgter Freischaltung wird im Anhängerbetrieb auch die rückwärtige Einparkhilfe automatisch deaktiviert!</p> <p>Aktivierung der Gespannstabilisierung</p> <p>Bei Fahrzeugen ab 06.06.2005, die werksseitig mit einem ABS-Steuergerät ausgestattet sind, welches die Gespannstabilisierung unterstützt, muss diese Funktion zwingend aktiviert werden.</p> <p>Passen sie hierzu das ABS-Steuergerät -J104 mit der geführten Fehlersuche wie folgt an:</p> <ul style="list-style-type: none"> • Geführte Fehlersuche • Fahrzeug auswählen > weiter (Fahrzeugsystemtest) > weiter • Mit „Sprung“ in „Funktions-Bauteil Auswahl“ • Fahrwerk • Bremsanlage • 01 – Eigendiagnosefähige Systeme • Antiblockiersystem • Funktionen • Anpassung -J104 mit Gespannstabilisierung weiter den Menü-Anweisungen folgen <p>Sollte diese Anpassungsmöglichkeit im Menü des ABS-Steuergerätes nicht aufgeführt sein, wird die Gespannstabilisierung von dem verbauten Steuergerät nicht unterstützt.</p> <p>Anpassen des Bordnetzsteuergerätes</p> <p>Wird die fahrzeugseitige Nebelschlussleuchte bei Anhängerbetrieb nicht abgeschaltet, muss gegebenenfalls das Bordnetzsteuergerät wie folgt codiert werden:</p> <ul style="list-style-type: none"> • Adresswort 09 – Elektronische Zentralelektrik • Identifikation: Weiter • Diagnosefunktion auswählen: 007 – Codierung (Dienst 1A) • Fahrzeugsystem auswählen: Bordnetz-SG Codierung lang • Wert ändern: Byte 8 Bit-Muster x1xxxxxx (x: die vorhandenen Werte in das Eingabefeld eingeben) Dazu auf Eingabemodus [BIN] schalten. 	<p>Encoding the gateway controller</p> <p>The vehicle gateway must be encoded, as described below, under the point self-diagnostics, by means of a VAS tester for functional expansion of the towing hitch function:</p> <ul style="list-style-type: none"> • Vehicle self-diagnosis • Gateway assembly list • 19 – diagnosis interface for data bus • 007-Coding (service \$1A) \ Read / write • long coding • 69 – trailer function (switch to coded!) <p>Vehicles with park assist system</p> <p>After the effected connection, the rear park assist system will also automatically be deactivated in trailer operation!</p> <p>Activating the trailer stabilisation</p> <p>For vehicles from 06.06.2005 that have a factory-fitted an ABS controller that supports the trailer stabilisation, is absolutely necessary to activate the following functions.</p> <p>For this purpose, adapt the ABS controller -J104 using the guided troubleshooting as follows:</p> <ul style="list-style-type: none"> • Guided troubleshooting • Select the vehicle > continue (vehicle system test) > continue • Use "Jump" to enter "Function component selection" • Chassis • Brake system • 01 – Self-diagnostics capable system • Anti-lock brake system • Functions • Adapting -J104 with trailer stabilisation • Continue with menu instructions <p>If this possibility for adapting should not be listed in the menu of the ABS controller, the trailer stabilisation is not supported by the controller installed.</p> <p>Adapting the on-board power control unit</p> <p>If the rear fog light on the towing vehicle is not disabled when towing a trailer, the on-board power control unit has to be encoded as follows where necessary:</p> <ul style="list-style-type: none"> • Address word 09 – Central electrical system • Identification: Continue • Selecting diagnosis function: 007 – Coding (Service 1A) • Select vehicle system: On-board power control unit – control unit encoding long • Change the value: Byte 8 Bit pattern x1xxxxxx (x: enter the existing values in the input field) For this purpose switch to input mode [BIN].

F

Codage du calculateur Gateway

Coder comme suit le Gateway du véhicule selon la description suivante, point diagnostic final, avec un contrôleur VAS pour l'extension du dispositif d'attelage :

- autodiagnostic du véhicule
- liste d'assemblage gateway
- 19 – interface de diagnostic pour bus de données
- 007-codage (service \$1A) \ lire / écrire uncode long
- 69 – mode remorque (commuter à encodé!)

Véhicules avec système d'aide au parking

Après l'activation, l'aide au parking arrière est également désactivé automatiquement dans le mode remorque!

Activation de l'assistance de stabilisation d'attelage

Pour les véhicules à compter de l'année 06.06.2005, qui sont équipés à l'usine d'un calculateur ABS qui soutient la stabilisation de l'attelage, cette fonction doit être impérativement activée.

Adapter pour cela le calculateur ABS J104 avec la recherche guidée des erreurs comme suit:

- Recherche guidée des erreurs
- Sélectionner le véhicule
 - > Continuer (test système du véhicule)
 - > Continuer
- Avec "Saut" passer à "Sélection de composant/fonction"
- Train roulant
- Freins
- 01 - Systèmes à auto-diagnostic
- Système antiblocage
- Fonctions
- Adaptation J104 avec stabilisation d'attelage
- Continuer à suivre les instructions du menu

Si cette possibilité d'adaptation n'est pas explicitée dans le menu du calculateur ABS, la stabilisation d'attelage n'est pas prise en charge par le calculateur.

Adaptation du calculateur du réseau de bord

Si les feux antibrouillard du véhicule ne sont pas éteints lorsque la remorque est attelée, coder éventuellement le calculateur du réseau de bord comme suit :

- Mot d'adresse 09 - Système électrique central électronique
- Identification : Continuer
- Sélectionner la fonction diagnostic : 007 - Codage (service 1A)
- Sélectionner le système du véhicule : Réseau de bord
Codage calculateur long
- Modifier la valeur du code : Octet schéma 8 bits x1xxxxx (x: entrer les valeurs dans le champ de saisie)
A cette fin, basculer sur le mode de saisie [BIN].

I

Codifica della centralina gateway

Il gateway della vettura, per l'espansione delle funzioni al gancio traino, deve essere codificato con un tester VAS nell'autodiagnosi, nel modo descritto qui di seguito:

- Autodiagnosi del veicolo
- Lista del Gateway
- 19 – Interfaccia di diagnosi per il data bus
- 007-codifica (servizio \$1A) \ Lettura e scrittura di codici lunghi
- 69 – Funzione rimorchio (commutare su codificato!)

Veicoli con sensori di parcheggio

Dopo aver completato l'attivazione, i sensori di parcheggio posteriori vengono disattivati automaticamente quando è attaccato un rimorchio!

Attivazione dello stabilizzatore di coppia

Per le vetture a partire dal modello 2006 (dal 06.06.2005), dotate di serie di centralina ABS con supporto per lo stabilizzatore di coppia, occorre assolutamente attivare questa funzione.

Adattare la centralina ABS -J104 con la ricerca anomalie guidata, nel modo seguente:

- ricerca anomalie guidata
- selezionare la vettura
 - > avanti (test di sistema della vettura)
 - > avanti
- con "Salta", passare alla "Selezione del componente funzionale"
- autotelaio
- impianto frenante
- 01 – sistemi con funzione di autodiagnosi
- sistema antibloccaggio
- funzioni
- adattamento -J104 con stabilizzatore di coppia
- quindi seguire le istruzioni del menu

Nel caso in cui questa possibilità di adattamento non sia riportata nel menu della centralina ABS, lo stabilizzatore di coppia non viene supportato dalla centralina installata.

Adattamento della centralina della rete di bordo

Se la luce retronebbia, con il rimorchio agganciato, non si spegne, occorre codificare la centralina della rete di bordo nel modo seguente:

- codice indirizzo 09 – impianto elettrico centrale elettronico
- identificazione: avanti
- selezionare la funzione diagnostica: 007 – codifica (servizio 1A)
- selezionare il sistema vettura: rete di bordo – codifica centralina lunga
- modificare il valore: byte 8 modello bit x1xxxxx (x: inserire i valori presenti nel campo d'immissione)
A tale scopo passare alla modalità d'immissione [BIN].

NL	E
<p>Coderen van het gateway besturingsapparaat</p> <p>De gateway aan voertuigzijde moet zoals hierna beschreven onder punt Eigendiagnose, met een VAS-tester voor de functie-uitbreiding aanhangwageninrichting</p> <ul style="list-style-type: none"> • Eigen diagnose voertuig • Gateway-inbouwlĳst • 19 – diagnose-interface für gegevensinvoerbus • 007-Codering (dienst \$1A) \ Lange codering lezen/schrijven • 69 – aanhangwagenfunctie (op "Gecodeerd" schakelen!) <p>Voertuigen met parkeerhulp</p> <p>Nadat de activering doorgevoerd werd, wordt in de modus „Aanhangwagen“ ook het hulpmiddel bij het achterwaartse, invogende parkeren automatisch geactiveerd!</p> <p>Activering van de aanhangwagenstabilisatie</p> <p>Bij voertuigen vanaf productiedatum 06.06.2005, die af fabriek met een ABS-besturingstoestel zijn uitgerust, die de aanhangwagenstabilisatie ondersteunt, moet deze functie beslist worden geactiveerd.</p> <p>Pas hiervoor het ABS-besturingstoestel -J104 met interactief foutzoeken als volgt aan:</p> <ul style="list-style-type: none"> • Interactief storingzoeken • Voertuig selecteren > verder (voertuigstysteemtest) > verder • Met „Sprong“ in de „Selectie functiecomponenten“ • Chassis • Reminstallatie • 01 – Voor eigendiagnose geschikte systemen • Antiblokkeersysteem • Functies • Aanpassing -J104 met aanhangwagenstabilisatie • verder de menuaanwijzingen opvolgen <p>Wanneer deze aanpassingsmogelijkheid in het menu van het ABS-besturingstoestel niet zijn vermeld, wordt de aanhangwagenstabilisatie door het gemonteerde besturingstoestel niet ondersteund.</p> <p>Aanpassen van het boordnetbesturingstoestel</p> <p>Wanneer het mistachterlicht aan voertuigzijde bij werking met aanhangwagen niet wordt uitgeschakeld, moet eventueel het boordnetbesturingstoestel als volgt worden gecodeerd:</p> <ul style="list-style-type: none"> • Adreswoord 09 – Elektronische centrale elektrische systeem • Identificatie: Verder • Diagnosefunctie selecteren: 007 – Codering (Dienst 1A) • Voertuigstysteem selecteren: Boordnet – SG codering lang • Waarde veranderen: Byte 8 Bit-patroon x1xxxxx (x: de aanwezige waarde in het invoerveld invoeren) Hiervoor op invoermodus [BIN] schakelen. 	<p>Codificación de la unidad de control del Gateway</p> <p>El Gateway del vehículo debe codificarse con un analizador VAS para ampliar las funciones del dispositivo de remolque en el autodiagnóstico, como se describe seguidamente:</p> <ul style="list-style-type: none"> • Autodiagnóstico del vehículo • Lista Gateway • 19 - Interfaz de diagnóstico para bus de datos • 007-Codificación (servicio \$1A) \ Leer / escribir la codificación larga • 69 - Función del remolque (codificación) <p>Vehículo lĳlevar a cabo la codificación de la siguiente manera:</p> <p>¡Tras haber realizado la activación , también se desactivará automáticamente la ayuda trasera al aparccamiento en la conducción con remolque!</p> <p>Activación del sistema de estabilización del remolque</p> <p>En los vehículos a partir del año de 06.06.2005, que están equipados de fábrica con una unidad de control para ABS que da apoyo a la estabilización del remolque, es imprescindible activar esta función.</p> <p>Adapte a tal fin la unidad de control -J104 para ABS con la búsqueda guiada de errores del siguiente modo:</p> <ul style="list-style-type: none"> • Búsqueda guiada de errores • Seleccionar vehículo > Continuar (test de sistema del vehículo) > Continuar • Con "Salto" en "Selección de función/componente" • Chasis • Sistema de frenos • 01 – Sistemas aptos para autodiagnóstico • Sistema antibloqueo • Funciones • Adaptación -J104 con estabilización del remolque • Seguir a continuación las instrucciones del menú <p>Si esta posibilidad de adaptación no apareciera mencionada en el menú de la unidad de control para ABS, la unidad de control instalada no dará apoyo a la estabilización del remolque.</p> <p>Adaptar la unidad de control de la red de a bordo</p> <p>Si la luz antiniebla trasera del vehículo no se desconecta durante la conducción con remolque, se deberá codificar eventualmente la unidad de control de la red de a bordo de la siguiente manera:</p> <ul style="list-style-type: none"> • Código 09 – Sistema eléctrico central electrónica • Identificación: Otros • Seleccionar función de diagnóstico: Codificación 007 (servicio 1A) • Seleccionar sistema del vehículo: Codificación larga unidad de control red de a bordo • Cambiar valor: Byte 8 configuración de bits x1xxxxx (x: introducir los valores existentes en el campo de entrada) Para ello, cambiar al modo de entrada [BIN].

57 CHECK

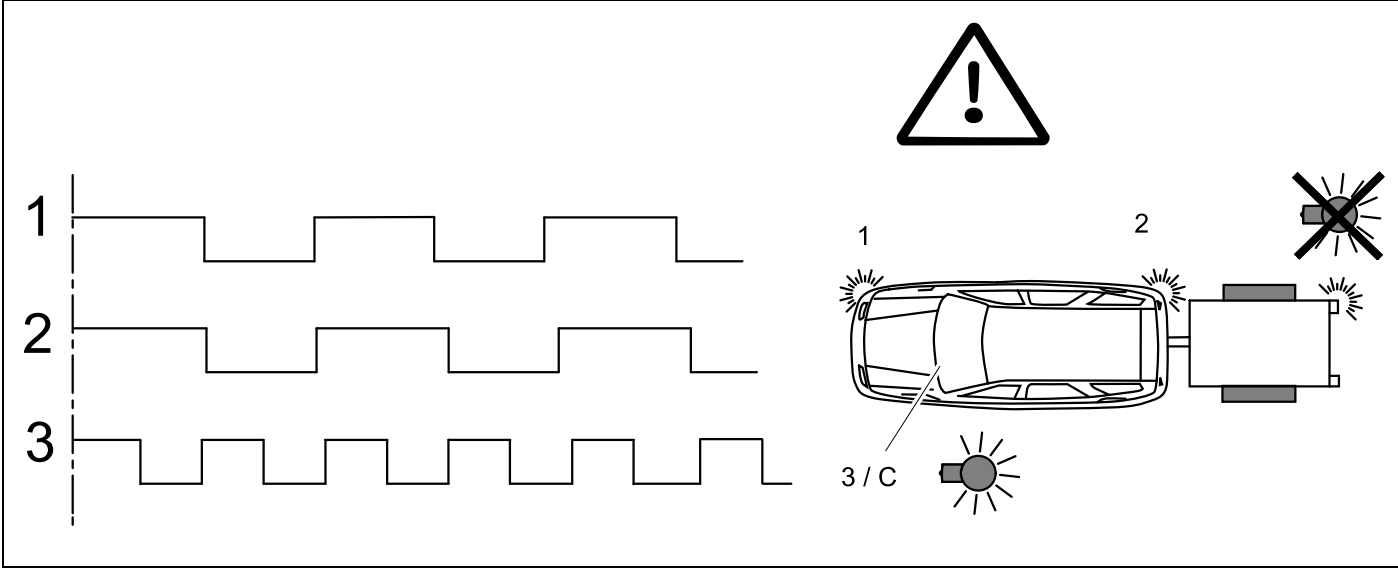

58 CHECK OPTION ORIGINAL PDC

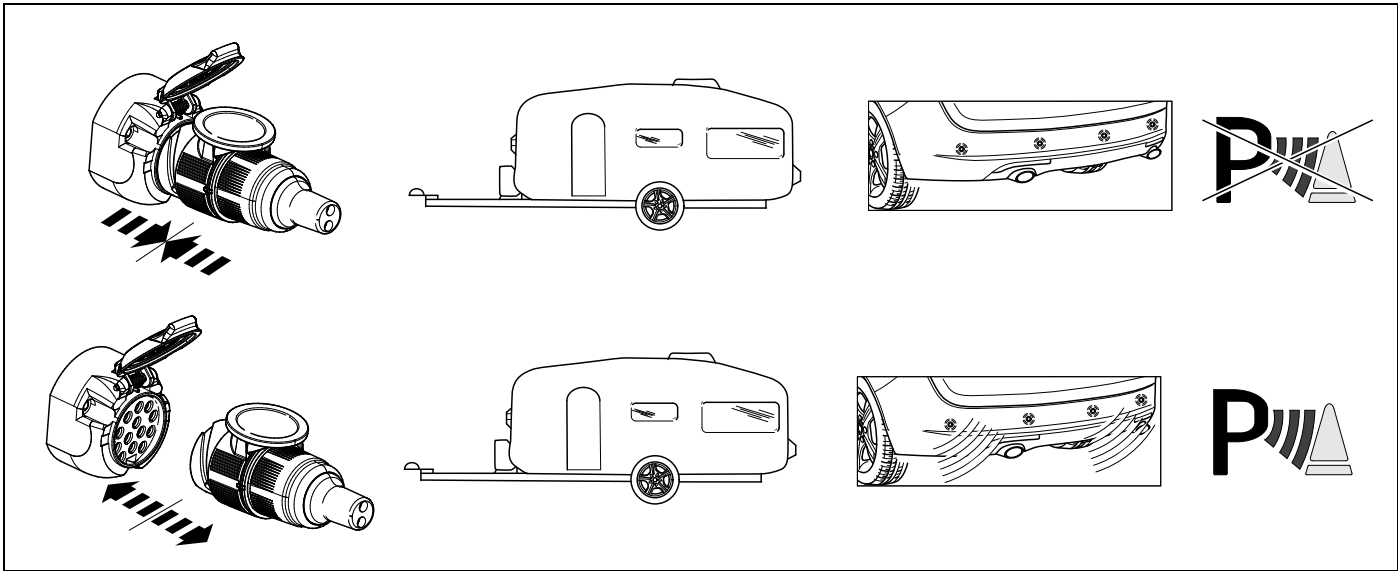

59 Information Service  \Rightarrow **41** + **45**

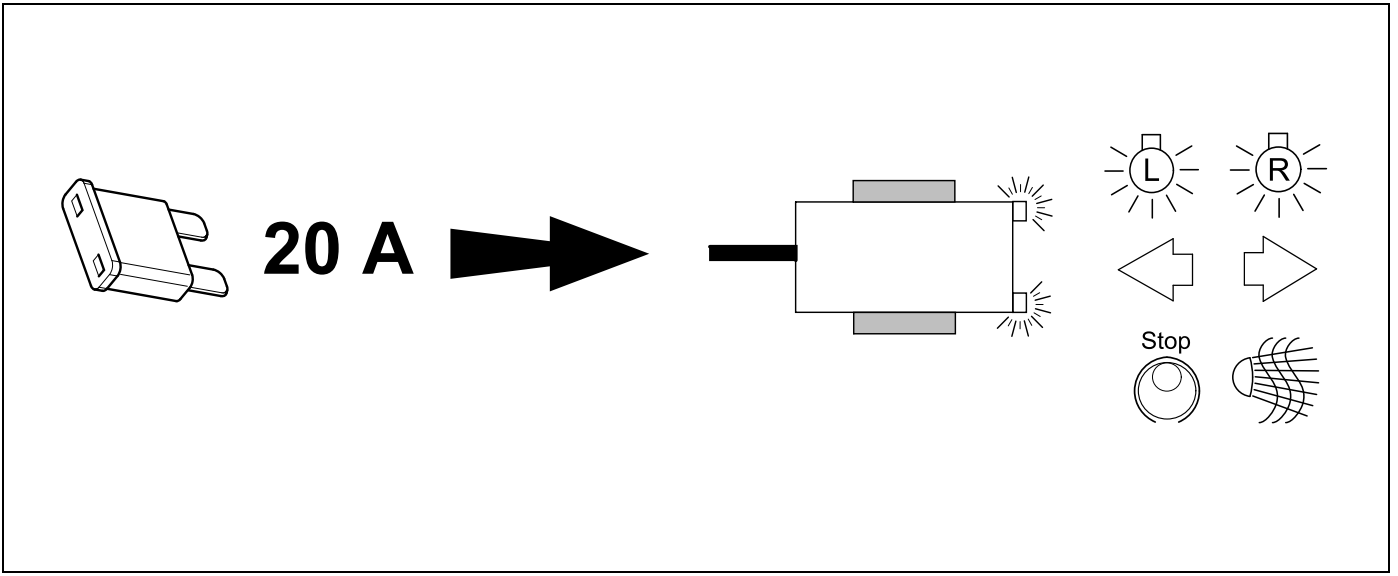

60 OPTIONAL

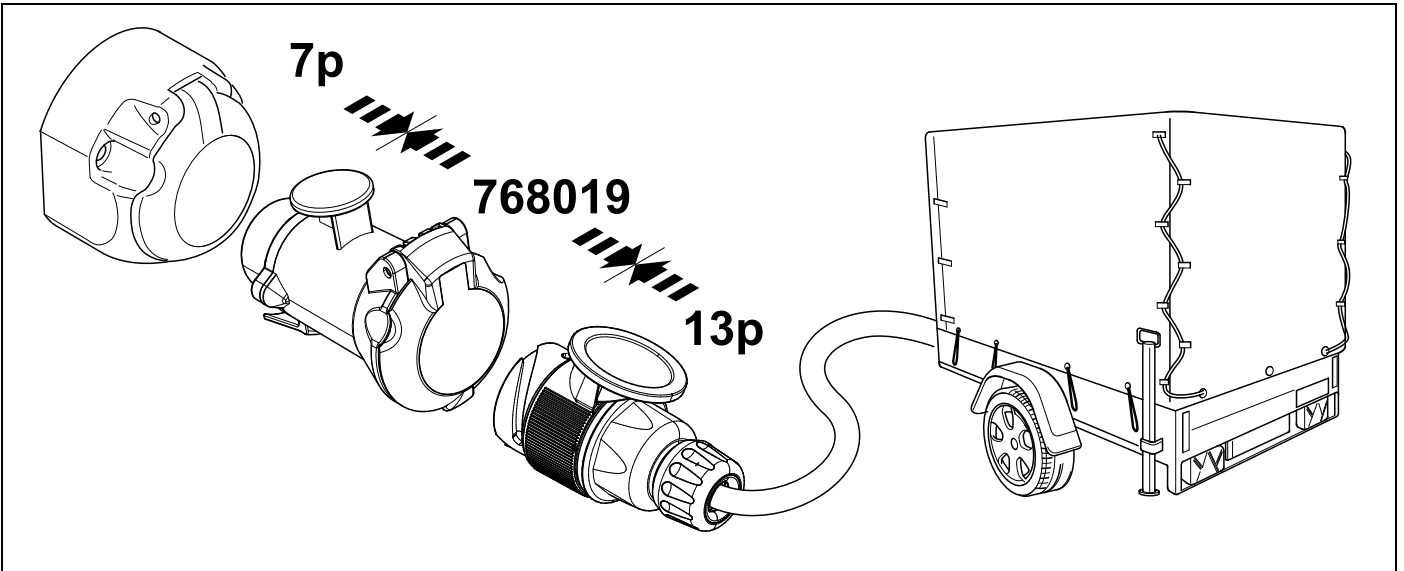

61 PLEASE NOTICE

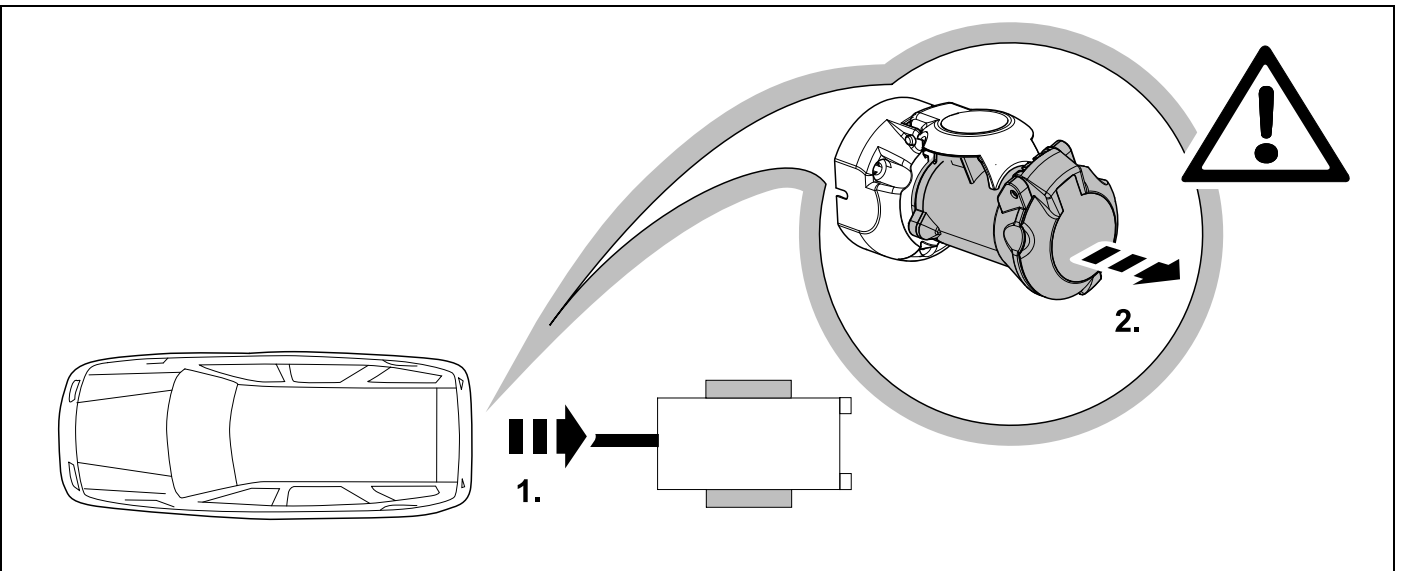



2x 13

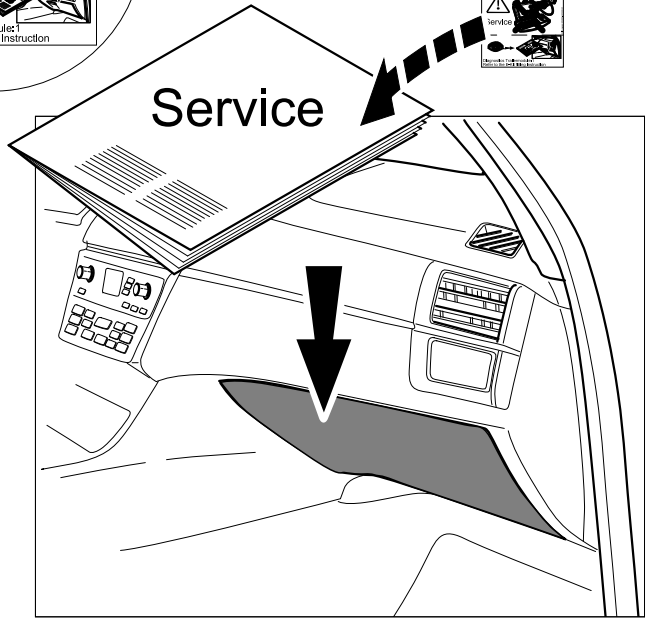
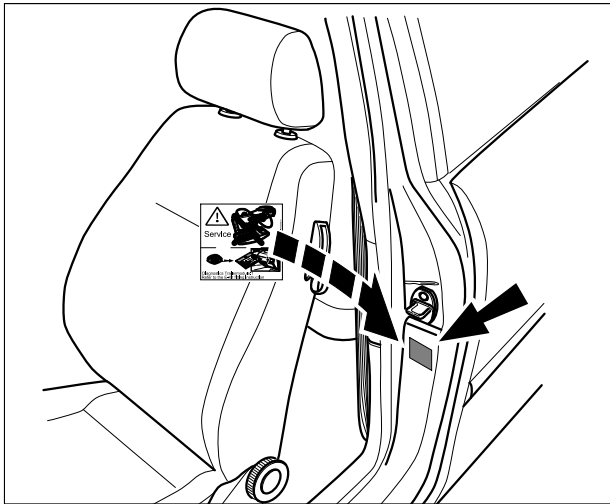
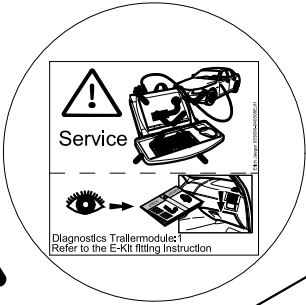

Status LED für Eigendiagnose

Status LED for self-diagnosis

Operation support

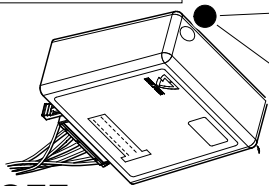
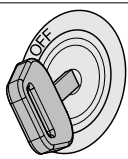

No CAN-Data =



Standby / Sleepmode

Ignition OFF

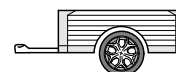
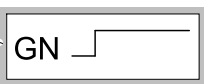
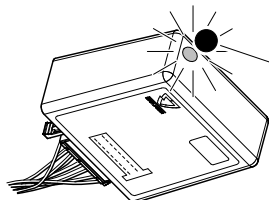
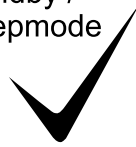

Ignition ON

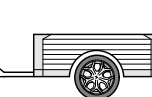
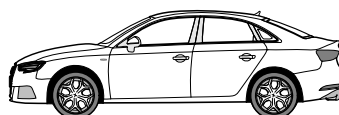
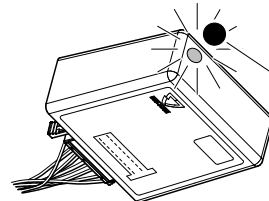
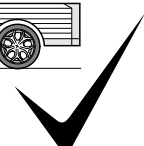

Ignition ON

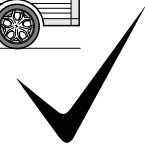

Failure support

CAN-Data Wire

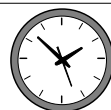

1x max. 5 min.

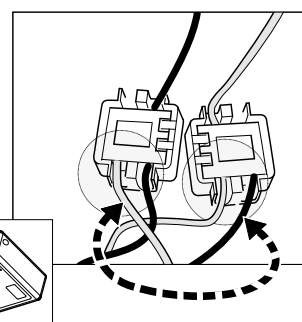
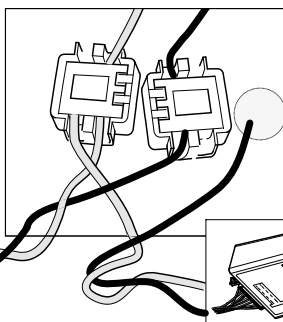
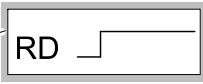
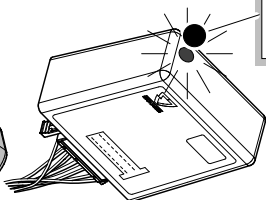

Ignition ON

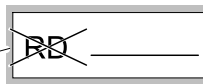
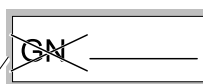
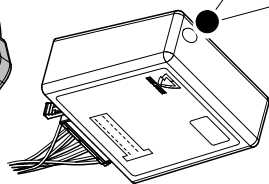
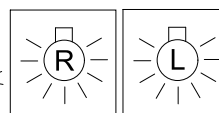
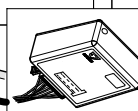
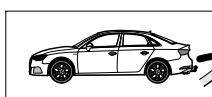

PIN 17 oder / or



PIN 1

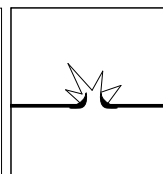
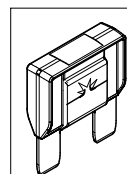
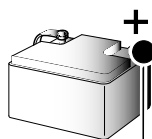

Ignition ON



<p>D Änderungen bezüglich Konstruktion, Ausstattung Farbe sowie Irrtum vorbehalten. Angaben und Abbildungen unverbindlich</p>	<p>PL Zastrzega się prawo do zmian dot. konstrukcji, wykończenia, kolorystyki oraz pomyłek. Dane i ilustracje niewiążące.</p>
<p>GB Subject to change in terms of construction, equipment and colour, and may contain errors. The information and illustrations are non-binding.</p>	<p>TR Tasarım, donanım ve renk bakımından değişiklik yapma hakkı ve hata ve eksiklik mahfuzdur. Veriler ve resimler bağlayıcı değildir.</p>
<p>F Sous réserve de modifications de la construction, de équipement, de la couleur et sous réserve d'erreurs. Les indications et les illustrations sont sans engagement.</p>	<p>H A szerkezet, a kivitell és a szín változtatása, valamint a változások joga fenntartva. Az adatok és az ábrák nem kötelező érvényűek.</p>
<p>NL Wijzigingen met betrekking tot constructie, uitvoering en kleur evenals vergissingen voorbehouden. Gegevens en afbeeldingen niet bindend.</p>	<p>HR Pravo promjena u svezi konstrukcije, opreme, boje kao i zabune oridžavamo. Podaci i ilustracije su neobavezne.</p>
<p>DK Ændringer med hensyn til konstruktion, udstyr, farver samt fejl forbeholdes. Oplysninger og illustrationer er uforpligtende.</p>	<p>BUL Запазени права по отношение на конструкцията, обзавеждането, цвета и грешки. Данните и изображенията не са обвързващи.</p>
<p>N Endringer angående konstruksjon, utstyr, farge og feiltagelse forbeholdes. Opplysninger og illustrasjoner uforbindtlig.</p>	<p>RO Ne rezervăm dreptul unor modificări ale construcției, dotării, culorii și dreptul la erori Datele indicate și imaginile sunt orientative.</p>
<p>S Med reservation för ändringar vad det gäller konstruktion, utrustning, färg samt för misstag. Uppgifterna och bilderna är inte bindande.</p>	<p>RU Права на внесение изменений относительно конструкции, оснащения, окраски, а также на ошибки сохраняются. Данные и иллюстрации имеют примерный характер.</p>
<p>FIN Pidätämme oikeuden rakennetta, varustusta, väriä koskeviin sekä erehdyksestä johtuviin muutoksiin. Tiedot ja kuvat eivät ole sitovia.</p>	<p>LT Pasiliekaama konstrukcijos, įrangos bei reikmenų, spalvos pakeitimų ir klaidų teisė. Duomenys ir iliustracijos neįpareigojantys.</p>
<p>I Con riserva di modifiche relative a progettazione, dotazione, colore ed errori. Le indicazioni e figure sono fornite senza impegno.</p>	<p>LV Tiek paturētas tiesības uz konstrukcijas, iekārtu, krāsu izmaiņām, kā arī kļūdīšanās. Dati un attēli bez saistībām.</p>
<p>E Reservadas las modificaciones respecto a diseño, equipamiento, color, así como error. Indicaciones y figuras sin compromiso.</p>	<p>EST Konstruktsiooni, varustuse ja võevi osas muudatused ning eksimine lubatud. Andmed ja joonised on mittesiduvad.</p>
<p>P Reservamos o direito de alterações relativamente ao desenho, equipamento, cor, bem como de erro. Os dados e as gravuras não implicam compromisso da nossa parte.</p>	<p>SLO Zadržana pravica do sprememb glede konstrukcije, opreme, barve ter pomote. Podatki in slike so neobvezne.</p>
<p>GR Διατηρώνουμε κάθε επιφύλαξη ως προς αλλαγές σε σχέση με κατασκευή, εξοπλισμό, διαρρυθμίση, χρωματισμούς και λάθη παραδρομής.</p>	<p>SK Zmeny, ktoré sa týkajú konštrukcie, vybavenia, farby, ako aj omyly sú vyhradené. Údaje a zobrazenia sú nezáväzné.</p>
<p>CZ Změny, týkající se konstrukce, vybavení, barvy, jakož i omyly jsou vyhrazeny. Údaje a vyobrazení jsou nezáväzné.</p>	